

## A NEW APPROACH TO PLASTIC DESIGN AND OPTIMIZATION OF PARALELL CHORD VIERENDEEL GIRDERS

M. Grigorian<sup>\*,†</sup>

MGA, Structural Engineering Inc. 111 N. Jackson St. Glendale, CA.91206, USA

### ABSTRACT

This study was prompted by the need to elaborate on recent developments in plastic design of, parallel chord Vierendeel girders (VG). The paper proposes exact, general solutions to two novel classes of VG under practical loading conditions, a-VG of uniform section, where the chords and the verticals may be composed of two different prismatic sections, and b-VG of uniform strength, where the constituent elements are selected in such a way as to induce a state of equal stress for all members of the structure. It has been shown that the total weight of both classes of VG can be minimized by the proper selection of the relative strengths of the members of each system. The essence of the paper is based on a novel failure mechanism presented for the first time in this article. It has been shown that racking moments can be utilized to conduct spot checks on final solutions. Several generic examples have been provided to demonstrate the applications and the validity of the proposed solutions.

Received: 20 February 2013; Accepted: 15 July 2013

KEY WORDS: vierendeel girders, plastic design, minimum weight, uniform strength

### 1. INTRODUCTION

Despite their increased use as parts of buildings and bridges [1, 2], the plastic design of VG has remained a scant subject in the literature [3-5] since the early 1960s. This may be attributed to the abundance of elastic design software as well as technical difficulties associated with the plastic design of such structures. VG are essentially horizontal moment frames that are ideally suited for plastic design treatment [6, 7]. They are frequently used as components of staggered

---

\*Corresponding author: M. Grigorian, MGA, Structural Engineering Inc. 111 N. Jackson St. Glendale, CA.91206, USA

†E-mail address: Markarjan@aol.com (M. Grigorian)

truss moment frames [8, 9], column free transfer podiums [10, 11] and similar frameworks. The developments introduced herein are facilitated greatly by presenting the plastic design of steel VG for two distinct categories of regular structural systems, VG of uniform cross section (UX) and VG of uniform strength (US). In regular VG the chords are identical and the bay lengths are the same. Two practical loading scenarios, an arbitrarily placed single normal nodal force and a uniform distribution of normal nodal forces have been considered for all categories of VG discussed in this article. In VG of UX, the chords and the verticals are composed either of identical or two different prismatic sections. The plastic moments of resistance of the chords and the verticals are symbolized as  $M^P$  and  $\mu M^P$  respectively.  $\mu$  is defined as the relative-strength factor of the vertical elements. It is shown that the introduction and proper selection of  $\mu$  can lead to substantial material savings for the class of VG considered in this category. In plastic design of VG of UX, member strengths are utilized to the utmost rather than curtailing the sections down to create a state of maximum allowable working stress throughout the structure. Failure modes are sensitive to changes in  $\mu$ . Therefore, each mode has been studied separately for  $2 \geq \mu \geq 1$  and  $1 \geq \mu \geq 0$  under each type of loading. In VG of US the relative strength factor of each vertical  $\mu_i$  is unique and depends upon the location of the member and the proportion of the racking moment imposed upon it. The analytic solutions of structures of US, such as laterally loaded moment frames [12-15] and regular VG provide minimum weight, perfect design envelopes for several member sizing strategies. In structures of US the limit state demand /capacity ratio is unity for all members of the framework, therefore no upgrading of members or groups of members can reduce the ultimate carrying capacity of the system. The knowledge that in structures of US all members tend to fail simultaneously [16, 17] provides an opportunity to control the sequences of formations of the plastic hinges as well as the total weight of the framing. Closed form generalized exact solutions have been worked out for both categories of VG introduced above. Despite their increased use as parts of buildings and bridges [1, 2], the plastic design of VG has remained a scant subject in the literature [3-5] since the early 1960s. This may be attributed to the abundance of elastic design software as well as technical difficulties associated with the plastic design of such structures. VG are essentially horizontal moment frames that are ideally suited for plastic design treatment [6, 7]. They are frequently used as components of staggered truss moment frames [8, 9], column free transfer podiums [10, 11] and similar frameworks.

### *1.1 Basic design assumptions*

The methodologies expounded in this presentation are based on the following assumptions, that;

- All members are capable of developing their full plastic moments of resistance, i.e., all sections are selected and detailed in accordance with the pertinent code requirements.
- Axial, shear and panel zone deformations do not effect the formation and rotation capacities of flexural plastic hinges. However, the need for doubler plates, stiffeners, etc, should be checked.
  - The possible benefits of strain hardening and yield over-strength can be ignored.
  - All design loads are applied at the joints and act monotonically throughout the history of loading of the structure.

- All joints are rigidly connected. Premature connection failure is prevented under all loading conditions.
- Axial, and shear forces have little to no effect on the kinematics or failure modes of the types of VG under consideration. However the effects of axial loads on the ultimate carrying capacities of all members should be taken into consideration before a final selection is made.
- The girders are externally determinate structures with no restraints against the free expansion of the chords in their own direction. This assumption is the key for developing the plausible failure mechanisms presented throughout this work.
- It has been assumed that the constituent beams of the girder are either weightless or their tributary weights can be included as part of the external nodal loading.

### 1.2 Basic design propositions

The essence of the current study is based on the following findings and their applications for practical design purposes.

- The categorization and introduction of two new classes of VG, their applications and relative merits. The current methods of computer aided elastic designs usually lead to either VG of nearly UX or curtailed down VG of US. The proposed methodologies may best be described as manual methods of approach that lead to similar systems with substantial material savings.
- The introduction and implementation of the relative strength factor  $\mu = M_{vertical}^P / M_{chord}^P$ , with a view to reducing total material consumption,  $G$ . The use of the relative strength factor for the vertical elements not only facilitates the design and optimization of any such VG, but also provides much needed insight into the performance of the framework at incipient collapse.
- The use of joint enhancement devices such as haunches, cover plates, etc. and the consideration of the physical plastic hinge offsets  $\alpha$  and  $\beta$  as part of the design strategy in order to enhance the performance of the structure and to reduce material consumption. A small effort devoted to the detailing of the joints can lead to significant savings in total materials consumption.
- The use of the kinematically plausible failure mechanisms as affected by the geometry and boundary support conditions of the VG, the loading, the relative strength factors as well as the hinge offsets. (The complete, correct collapse mechanism depicted in Figure2 has not appeared in the literature before.)
- The use of the racking moments as a quick and reliable means of verification of the postulated results. The use of the racking moments as the product of bay shear and bay length alleviates the need to conduct elaborate sectional equilibrium analysis.
- The use of the US theory has been extended to the plastic design of regular steel VG. Here, the author proposes a rather simple solution to a classically complicated problem.
- The presentation of generalized, exact, closed form ultimate load formulae for practical design purposes. The proposed formulae can be readily used to determine the plastic moments of resistance of regular VG under practical loading conditions.

1.3 Effects of hinge offsets

Plastic hinge offset is referred to the short distance between the point of intersection of structural members and the physical location of the centre of the plastic hinge along the neutral axis of the member under consideration. A depiction and practical classification of such offsets is presented in Figure 1 where  $h$  and  $L$  stand for typical bay height and length respectively. While the physical effects of joint offsets are commonly ignored in practical design considerations, their inclusion as part of the design strategy can significantly improve both the load carrying capacities as well as the displacement development characteristics of moment frames in general [18,19] and VG in particular. As depicted in Figures 1 and 2, the reduced values of the hinge spans in the verticals, force the plastic hinges to form a small distance  $b = (h - \bar{h})/2$  away from the center-lines of the adjoining beams. As a result, the plastic column rotation  $\psi = [(h/\bar{h}) + 1](\phi + \theta)$  becomes larger than the original rotation  $(\phi + \theta)$  of the selected failure mechanism. By the same token the plastic hinges a distance  $a = (L - \bar{L})/2$  away from the center-lines of the columns rotate through an increased angle  $sL\theta/(sL - 2a)$ . The ratios  $(h/\bar{h})$  and  $(L/\bar{L})$  are always larger than unity and are referred to as the moment control factors. A comparison of the plastic moments of resistance of the three joint models of Figure 1 reveals that the inclusion of the physical plastic hinge offsets as part of the design computations increases the beam and post capacities by as much as  $\xi = (1 - \partial_c)/(1 - 2\alpha)$  and  $\eta = (1 - \partial_b)/(1 - 2\beta)$  respectively, where  $\alpha = a/L$ ,  $\beta = b/h$ ,  $\partial_c = d_c/L$  and  $\partial_b = d_b/h$ . For all practical intents and purpose  $a$  and  $b$  range between  $d_{min} \geq (a \approx b) \geq 2d_{max}$ , where  $d_{min}$  is the lesser of the actual depths of the horizontal and vertical members of the joint, although any other combination may also be envisaged. The local over-strength factors of the end sections of the beams,  $\xi$  and columns  $\eta$ , needed to force the formation of the plastic hinges at the desired offset location may be specified as;

$$\xi = \frac{L - d_c}{L - 2a} = \frac{1 - \partial_c}{1 - 2\alpha} \quad \text{and} \quad \eta = \frac{h - d_b}{h - 2b} = \frac{1 - \partial_b}{1 - 2\beta} \tag{1}$$

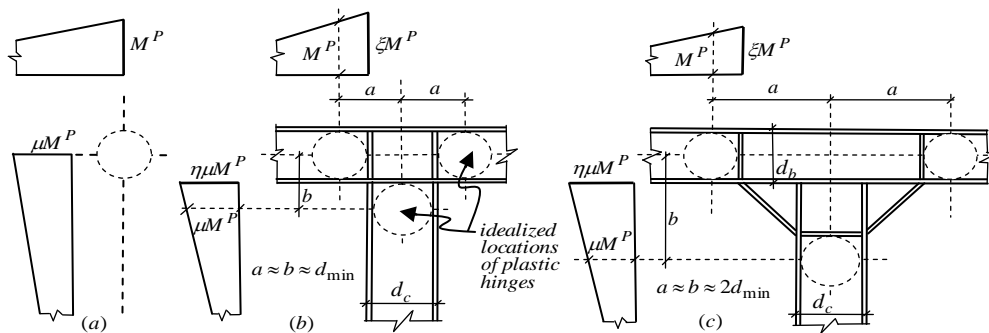

Figure 1. Effects of plastic hinge offsets on ultimate carrying capacities of moment connections, (a) Idealized plastic hinge with no offsets, (b) Simple rigid connection, (c) Simple connection with added haunches.

In order to compare the weight efficiencies of the two extreme systems (1a) and (1c), the

weight of each pair of haunches may be considered as equivalent to the weight of unit length of the heavier of the two members forming the structure. The total weight of each pair of haunches may therefore be estimated as  $\eta\mu\gamma M^P \partial_c h$  and  $\xi\gamma M^P \partial_c h$  for  $\mu \geq 1$  and  $\mu < 1$  respectively, where  $\gamma$  is a constant of proportionality [20]. For  $\alpha > 1$ ,  $\beta > 1$  and  $\mu > 1$  the total weight of the VG including the added haunches can be estimated as;

$$G = \gamma M^P [2nL + \mu(n+1)(1 - \partial_c)h + 2(n+1)\eta\mu\partial_c h] \tag{2}$$

## 2. VIRENDEEL GIRDERS OF UNIFORM SECTION

Unlike the familiar collapse mechanisms of symmetrically loaded VG, Figures 3 and 4, where the plastic hinges form symmetric failure patterns, the un-symmetrically loaded girders tend to fail through one sided local mechanisms as depicted in Figures 2b and 2c. What is uncommon about these collapse patterns is that all plastic hinges form on the side of the load that is closer to a support with all affected beam and column hinges rotating through the same total angles  $(\theta + \phi)$  and  $\psi$  respectively. This phenomenon is directly associated with larger racking moments caused by the larger reaction closer to the point load and the fact that the elements of the intact segment can not absorb the same rotations internally. Rotation  $\psi$  is a magnification of  $(\theta + \phi)$  due to plastic hinge offsets  $b$ , measured from idealized joint locations of the intersecting posts and chords. It is instructive to note that rotations  $\theta$  and  $\phi$  are associated with two interrelated rigid body displacements  $\Delta_{horiz.} = \phi h$  and  $\Delta_{vert.} = (n - s + \alpha)L\phi$ . The point of application of the applied load sinks a vertical distance  $(n - s)L\phi$ , which is shorter than  $\Delta_{vert.}$  by the small amount  $\alpha L\phi$ . It may be noted that the inclusion of the offsets as part of the design strategy, reduces the external work of the point load  $W$ , and hand increases the internal work of the plastic hinges. While  $\Delta_{horiz.}$  does not appear in the virtual work equation of the current problem, it indicates that a restraint at the upper chord level could drastically alter the envisaged failure mechanism and the corresponding collapse load.

### 2.1 Regular parallel chord VG of UX under arbitrarily placed point load $\mu \geq 1$

The failure mechanism corresponding to  $2 \geq \mu \geq 1$  is presented in Figure 2b, where the pair of plastic hinges at  $i=0$  occur at the left hand ends of the chords of the first bay instead of forming at the ends of the first vertical from the left for  $\mu < 1$  as depicted in Figure 2c. However, the generalized virtual work equation for the particular loading and haunch enhanced VG of UX of Figure 2b can be summarized as;

$$W(n - s)L\phi = 4M^P(\theta + \phi) + 2(s - 1)\mu M^P\psi \tag{3}$$

Substituting for  $\phi = \frac{(s - 2\alpha)\theta}{(n - s + \alpha)}$ ,  $\psi = \frac{(n - \alpha)\theta}{(1 - 2\beta)(n - s + \alpha)}$  and  $(\theta + \phi) = \frac{(n - \alpha)\theta}{(n - s + \alpha)}$  in Eq. (3),

it yields the exact and unique [21-23] solution for  $2 \geq \mu \geq 1$  as;

$$M^P = \left[ \frac{(n-s)(1-2\beta)(s-2a)}{2(1-2\beta) + (s-1)\mu} \right] \frac{WL}{2(n-a)} \tag{4}$$

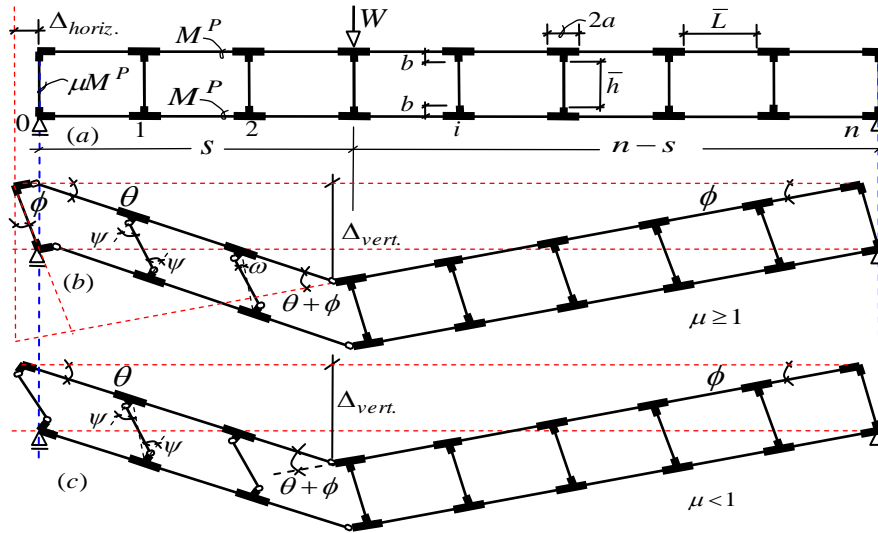

Figure 2. (a)Regular parallel chord vierendeel girder of UX under arbitrarily placed point load,(b) Unique failure mechanism with both vertical and horizontal displacement components for  $\mu \geq 1$ , (c) Unique failure mechanism with both vertical and horizontal displacement components for  $\mu \leq 1$

Note that the inclusion of the vertical offset  $b$  in the work Eq. (3) makes the load carrying capacity of the girder dependant on  $h$ , whereas Eq.(5) indicates that the classical condition  $a=b=0$  is totally independent of the geometric influence of  $h$  on  $W$ .

$$M^P = \left[ \frac{s(n-s)}{2 + (s-1)\mu} \right] \frac{WL}{2n} \tag{5}$$

The total weight of the same VG without due consideration to hinge offsets, i.e. for  $\alpha = \beta = 0$  and  $\mu > 1$ , can also be estimated as;

$$G_I = \gamma M^P [2nL + \mu(n+1)(1 - \partial_c)h] \tag{6}$$

2.1.1 Example 1

Given;  $n=6, L=h, s=2, \mu=2, \partial_c = \partial_b = 0.1L$  and  $a=b=0.2L$ ; compare the total weight efficiencies of the subject VG with and without added haunches.

*Solution:* From Eq. (1)  $\eta = (1 - \partial_b) / (1 - 2\beta) = 1.50$ , from Eq. (4)  $M_{haunch}^P = 0.1035WL$ . Eq. (2) gives;  $G_{haunch} = 28.8\gamma LM_{haunch}^P = 28.8 \times 0.1035\gamma WL^2 = 2.9808\gamma WL^2$ . Similarly Eqs. (5) and (8) give  $M^P = 0.1666WL$  and  $G = 24.6 \times 0.1666\gamma WL^2 = 4.0999\gamma WL^2$  respectively. The last term of Eq. (2) describes the total weight of the added haunches as  $0.4347\gamma WL^2$ . This implies that the inclusion of the offsets can increase the theoretical carrying capacity of the girder by as much as 40%. Conversely the total weight of the girder may be reduced by more than 25%.

2.1.2 Example 2

Verify the validity of Eq. (5) for  $\mu = 2$  and all values of  $s$  and  $n$ .

*Solution:* For  $\mu = 2$  Eq. (5) reduces to the simple formula;  $M^P = (n - s)WL / 4n$ . The support shear may be worked out as  $V_1 = (n - s)W / n$  and the corresponding racking moment of the first bay as,  $V_1L = (n - s)WL / n$ . Racking equilibrium of the first bay (measured from the left hand support) requires that;  $M_1 = [(n - s)WL / 2n] - M^P = 2M^P - M^P = M^P \leq M^P$ . Therefore, the solution is satisfactory. The yield criterion is intact, equilibrium has been satisfied and the failure mechanism is kinematically correct, and, as such the solution is unique and can not be far from a minimum weight design [24-26].

2.2. Centrally loaded regular parallel chord VG of UX,  $2 \geq \mu \geq 1$

The ultimate carrying capacity of the practically interesting case of a centrally loaded, idealized regular parallel chord VG of UX with zero offsets and  $\mu \geq 1$  may be directly obtained from Eq.(5) by substituting for  $s = n/2$ , i.e.,

$$M^P = \left[ \frac{n}{4 + (n - 2)\mu} \right] \frac{WL}{4} \tag{7}$$

2.3 Regular parallel chord VG of UX under arbitrarily placed point load  $\mu < 1$

The virtual work equation for the specific loading and VG of Figure 2c can be summarized as;

$$W(n - s)L\phi = 2M^P(\theta + \phi) + 2s\mu M^P\psi \tag{8}$$

Substituting for  $\phi = \frac{(s - \alpha)\theta}{(n - s + \alpha)}$ ,  $\psi = \frac{n\theta}{(1 - 2\beta)(n - s + \alpha)}$  and  $(\theta + \phi) = \frac{n\theta}{(n - s + \alpha)}$  in Eq. (8), it yields the exact solution for  $\mu < 1$  as;

$$M^P = \left[ \frac{(n - s)(1 - 2\beta)(s - \alpha)}{(1 - 2\beta) + s\mu} \right] \frac{WL}{2n} \tag{9}$$

The solution for the idealized VG of UX with zero offsets may be extracted from Eq.(9) as;

$$M^P = \left[ \frac{s(n-s)}{(1+s\mu)} \right] \frac{WL}{2n} \quad (10)$$

### 2.3.1 Verification

It might interest the reader to note that for  $\mu = 1$ , solutions (5) and (10) coincide. A quick and reliable means of verifying the validity of the virtual work solution (10) is to check the equilibrium and the status of the yield criterion of any bay of the framework that contains at least two plastic hinges. This may be achieved by considering the fact that the racking moment  $M_i^R = V_i L_i$  of any bay  $i$  is a statically determinate quantity that is equal to the sum of end moments of the chords of that bay. The first and the last bays of VG often carry the largest shear and the racking moments along the length of their chords and are ideally suited for static computations. Therefore, if the left hand side support reaction, the racking moment and the right end chord moments of the first bay of the subject girder are designated as  $R_L$ ,  $M_1^R$  and  $M_1$  respectively, then it may be shown that  $R_L = W(n-s)/n$  and  $M_1^R = WL(n-s)/n$ . The static equilibrium of this particular bay at incipient collapse requires that;

$$M_1^R = \frac{(n-s)WL}{n} = 2\mu M^P + 2M_1 \quad (11)$$

Substituting for  $M^P$  from (10) into (11) gives, after some rearrangement;

$$M_1 = \left[ \frac{(n-s)}{(1+s\mu)} \right] \frac{WL}{2n} = \frac{M^P}{s} < M^P \quad (12)$$

Eq. (12) indicates that static equilibrium has been satisfied and that the yield criterion has not been violated. Therefore the proposed solution is unique, exact and valid. While there is no need to repeat the verification process, it might add insight to estimate the remaining unknown moments for all other bays containing plastic hinges.

### 2.3.2 Centrally loaded regular parallel chord VG of UX, $\mu \leq 1$

The ultimate carrying capacity of a centrally loaded regular parallel chord VG of UX for  $\mu < 1$  may be directly obtained from Eq. (10) by substituting for  $s=n/2$ , thus;

$$M^P = \left[ \frac{n}{(2+\mu n)} \right] \frac{WL}{4} \quad (13)$$

As anticipated, Eqs. (7) and (13) yield the same results for VG of UX with  $\mu = 1$ .



2.4 Regular parallel chord VG of UX under uniformly distributed normal nodal loading

As practical cases of interest, the plastic limit state analysis of regular, parallel chord, haunch enhanced VG of UX under uniformly distributed normal nodal forces for both shear as well as flexural type collapse modes, is presented in this section. The shear modes, as depicted in Figure 3, are those in which the plastic hinges of the chords form one or more bays away from the center line of the structure.

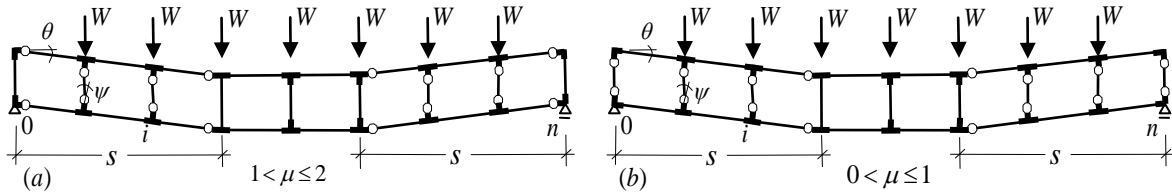

Figure 3. Shear type failure mechanisms for regular, parallel chord vierendeel girder under uniform loading, (a) Support region hinges forming within end chords, (b) Support region hinges forming within end posts

2.4.1 The Shear mode  $2 \geq \mu \geq 1$  and  $n \geq 3$

The location of formation of the interior chord hinges is denoted by the integer  $s$  for both cases. The generalized virtual work equation pertaining to the shear type mechanism of Figure 3a for a VG of UX under a uniform distribution of normal nodal forces can be expressed as;

$$W(n - 2s + 1)(s - 2\alpha)L\theta + 2\sum_{i=1}^{s-1} WL(i - \alpha)\theta = 4(s - 1)\mu M^P\psi + 8M^P\theta \quad (14)$$

Substituting for  $\psi = \theta/(1 - 2\beta)$  in Eq. (14) gives after simplifications;

$$M^P = \left[ \frac{(n - s)(s - 2\alpha)(1 - 2\beta)}{2(1 - 2\beta) + \mu(s - 1)} \right] \frac{WL}{4} \quad (15)$$

The correct value of the integer,  $s$  corresponds to the maximum  $M^P$  and may be computed from  $\frac{\partial M^P}{\partial s} = 0$ , thus;

$$\mu s^2 + 2[2(1 - 2\beta) - \mu]s - \{[2(1 - 2\beta) - \mu](n + 2\alpha) - 2\alpha\mu n\} = 0 \quad (16)$$

which, in turn gives  $s$  as the nearest whole number to;

$$s = -[2(1 - 2\beta) - \mu] + \sqrt{[2(1 - 2\beta) - \mu]^2 + \{[2(1 - 2\beta) - \mu](n + 2\alpha) - 2\alpha\mu n\} / \mu}, \quad (17)$$

The solution for the idealized VG of UX with zero offsets may be obtained from Eq. (15)

as;

$$M^P = \left[ \frac{s(n-s)}{2+(s-1)\mu} \right] \frac{WL}{4} \quad (18)$$

and

$$s = [-(2-\mu) + \sqrt{(2-\mu)^2 + (2-\mu)n\mu}] / \mu \quad (19)$$

#### 2.4.2 The Shear mode, $1 \geq \mu \geq 0$ and $n \geq 3$

The generalized virtual work equation for the shear type mechanism of Figure 3b, where the support region plastic hinges form at the ends of the first vertical can be expressed as;

$$W(n-2s+1)(s-2\alpha)L\theta + 2 \sum_{i=1}^{s-1} WL(i-\alpha)\theta = 4s\mu M^P \psi + 4M^P \theta \quad (20)$$

Substituting for  $\psi = \theta/(1-2\beta)$  in Eq. (20) gives, after eliminating  $\theta$

$$M^P = \left[ \frac{(n-s)(s-2\alpha)(1-2\beta)}{(1-2\beta) + \mu s} \right] \frac{WL}{4} \quad (21)$$

Once again, the correct value of  $s$  corresponding to the maximum  $M^P$  and may be computed from  $\frac{\partial M^P}{\partial s} = 0$ , thus;

$$\mu s^2 + 2(1-2\beta)s - [(n+2\alpha)(1-2\beta) + 2\alpha\mu n] = 0 \quad (22)$$

which in turn gives  $s$  as the nearest whole number to

$$s = -2(1-2\beta) + \sqrt{(1-2\beta)^2 + [(n+2\alpha)(1-2\beta) + 2\alpha\mu n]\mu} / \mu, \quad (23)$$

The corresponding of the idealized VG with zero offsets may be deducted from Eq. (21) as;

$$M^P = \left[ \frac{s(n-s)}{\mu s + 1} \right] \frac{WL}{4} \quad (24)$$

this in turn gives  $s$  as the nearest integer to

$$s = [-1 + \sqrt{1+n\mu}] / \mu \quad (25)$$

As expected, solutions (18) and (24) coincide at  $\mu = 1$ . It is insightful to note that nearest

integer to  $s$  reduces towards unity with increasing  $\mu$  and points towards the formation of a shear type failure, whereas, the same integer increases towards  $n/2$  with diminishing  $\mu$  and hints at the possibility of formation of a flexural failure mechanism. The flexural type failure can also be regarded as a special case of the generalized shear type collapse.

2.4.2.1 Example 3

Demonstrate the use of Eqs. (24) and (25) for the practical range of variation of  $2 \leq n \leq 20$ .

*Solution:* The solution of Eq. (24) for normal ranges of applications of  $n$  and  $\mu=1$  is presented in Table 1. The corresponding total weight function for the VG of regular formation based on zero offsets and shear type modes of failure may be computed as;

$$G = \gamma LM^P [2n + (n + 1)\alpha\mu] = [2n + (n + 1)k\mu] \left[ \frac{s(n - s)}{\mu s + 1} \right] \frac{\gamma WL^2}{4} \text{ for } 0 < \mu \leq 1 \quad (26)$$

$$G = \gamma LM^P [2n + (n + 1)\alpha\mu] = [2n + (n + 1)k\mu] \left[ \frac{s(n - s)}{[2 + (s - 1)\mu]} \right] \frac{\gamma WL^2}{4} \text{ for } 2 > \mu \geq 1 \quad (27)$$

where  $k = h/L$  and  $\gamma$  are the aspect ratio and a constant relating weight per unit length to plastic moment of resistance respectively. For practical ranges of application, i.e.  $3 < n < 20$ , the post relative strength factor for minimum weight ranges from  $\mu = 1$  to  $\mu = 1.5$ .

Table 1: Variations of  $s$  and  $M^P$  with respect to  $n$  for  $\mu = 1$

|                  |               |               |               |               |               |               |               |               |               |               |                 |                 |                 |                 |                 |                 |                 |                 |                |
|------------------|---------------|---------------|---------------|---------------|---------------|---------------|---------------|---------------|---------------|---------------|-----------------|-----------------|-----------------|-----------------|-----------------|-----------------|-----------------|-----------------|----------------|
| $n$              | 2             | 3             | 4             | 5             | 6             | 7             | 8             | 9             | 10            | 11            | 12              | 13              | 14              | 15              | 16              | 17              | 18              | 19              | 20             |
| $s$              | 1             | 1             | 1             | 1             | 2             | 2             | 2             | 2             | 2             | 2             | 3               | 3               | 3               | 3               | 3               | 3               | 3               | 3               | 4              |
| $\frac{M^P}{WL}$ | $\frac{1}{8}$ | $\frac{2}{8}$ | $\frac{3}{8}$ | $\frac{5}{8}$ | $\frac{4}{6}$ | $\frac{5}{6}$ | $\frac{6}{6}$ | $\frac{7}{6}$ | $\frac{8}{6}$ | $\frac{9}{6}$ | $\frac{27}{16}$ | $\frac{30}{16}$ | $\frac{33}{16}$ | $\frac{36}{16}$ | $\frac{39}{16}$ | $\frac{42}{16}$ | $\frac{45}{16}$ | $\frac{48}{16}$ | $\frac{16}{5}$ |

2.4.2.2 Example 4

Verify the validity of Eqs. (18) and (24) for  $\mu = 1$  and  $n=6$ .

*Solution:* From Table 1;  $s=2$  and  $M^P = 2WL/3$ . The left hand support shear may be calculated as  $V_1 = 5W/2$  and the corresponding racking moments as,  $V_1L = 5WL/2$ . Racking equilibrium requires that;  $M_1 = \frac{(n-1)WL}{4} - M^P = \frac{5WL}{4} - M^P = \frac{5}{4} \times \frac{3}{2} M^P - M^P = \frac{7}{8} M^P < M^P$ .

Therefore the solution is satisfactory.

2.4.2.3 Example 5

The purpose if this example is to demonstrate how the total weight of a VG of UX can be optimized under practical loading conditions. Given;  $n=6$  and  $h=L$  find the value of  $\mu$  for which the total weight of the VG under study is a minimum.

*Solution:* As a point of reference, Table1, or Eqs.(18) or (24)give for  $\mu = 1$ ;  $s = 2M^P = 2WL/3$ . A plot of  $G$  against  $2 \geq \mu \geq 0$ , as shown in Figure 5, indicates that for this particular example the total weight is a minimum at  $\mu = 1.0$ , whereas the minimum  $M^P$  corresponds to  $\mu = 1.2$ . Obviously similar plots may be drawn for all practical combination of  $k, n$  and  $\mu$ .

2.5 The flexural mode VG of UX

Flexural type failures such as those depicted in Figure 4 can also be regarded as special cases of the generalized shear type collapse, and as such it becomes instructive to find at what value of  $\mu$  the two modes coincide? This may be achieved by comparing the virtual work equations of the two modes or by putting  $s = (n - 1)/2$  in Eq. (25) and solving for  $\mu$ .

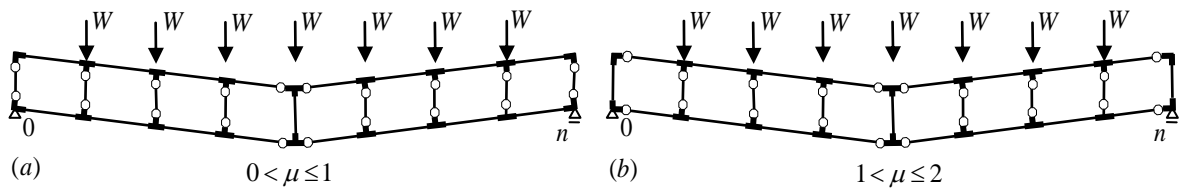

Figure 4. Flexural type failure mechanisms for regular, parallel chord vierendeel girder under uniform loading, (a) Support region hinges forming within end struts, (b) Support region hinges forming within end chords

2.5.1 The flexural mode,  $0 \geq \mu \geq 1$

The virtual work equation for failure mode (4a) where the support region plastic hinges form at the ends of the verticals rather than the ends of the chords may be expressed as;

$$(n^2 + \delta_1^n) \frac{WL\theta}{4} - \frac{4W\alpha L}{4} (n - \delta_1^n)\theta = 4M^P\theta + 2(n + \delta_1^n)\mu M^P\psi \tag{28}$$

Substituting for  $\psi = \theta/(1 - 2\beta)$  in Eq.(28), it gives after eliminating  $\theta$  and rearranging for  $M^P$ ;

$$M^P = \left\{ \frac{(1 - 2\beta)[(n^2 + \delta_1^n) - 4\alpha(n - \delta_1^n)]}{2(1 - 2\beta) + (n + \delta_1^n)\mu} \right\} \frac{WL}{8} \tag{29}$$

where,  $\delta_1^n = [(-1)^n - 1]/2$  has been introduced to account for both even and odd numbers of bays ( $\delta_1^n = 0$  for  $n = \text{even}$  and  $\delta_1^n = -1$  for  $n = \text{odd}$ ). The classical solution of Eq. (28), for  $\alpha = \beta = 0$  can be derived directly from Eq. (29) as;

$$M^P = \frac{(n^2 + \delta_1^n)WL}{8[2 + (n + \delta_1^n)\mu]} \tag{30}$$

Next, putting  $\alpha = \beta = 0$  and  $s = (n-1)/2$  in Eq. (25) and solving for  $\mu$ , it gives  $\mu = 4/(n-1)^2$ , which implies that the condition  $0 < \mu \leq 1$  can be satisfied only when  $n > 3$ .

2.5.1.1 Example 6

Compare the economics of the shear and flexural failure modes for the VG of example 2.

*Solution:* From Eq. (25) flexural type failure can occur only when  $\mu \leq [4/(6-1)^2 = 0.16]$ .

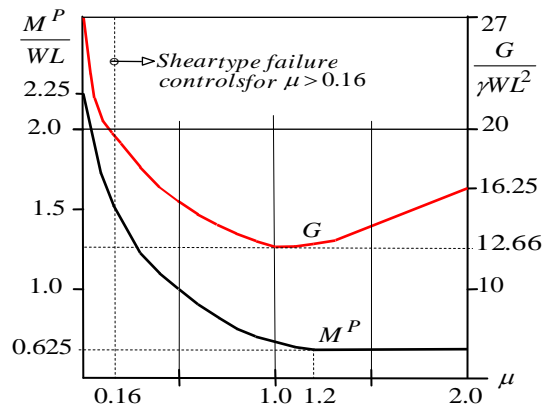

Figure 5. Variations of G and  $M^P$  for examples 1 and 2

The weight curve of Figure 5 indicates that the flexural type failure offers the least economical option compared with all values of  $\mu$  associated with shear type collapse.

**3. VIERENDEEL GIRDERS OF UNIFORM STRENGTH**

In VG of UX the relative strength of the vertical members with respect to those of the chords is signified by a single variable  $2 \geq \mu > 0$ . It was shown that  $\mu$  could be selected in such a way as to engage as many members with plastic hinges at both ends of as possible, thereby reducing the total material weight to a practical minimum. The question that arises is, if it is possible to define a  $\mu_i$  for any bay  $i$ , such that all members of the structure would fail in a state of over complete collapse, with plastic hinges forming simultaneously at both ends of all members? If this can be achieved then the system would be one of US and by default one of absolute minimum weight. While this sounds as a complicated proposition, its solution is simple and the comprehension easy to follow.

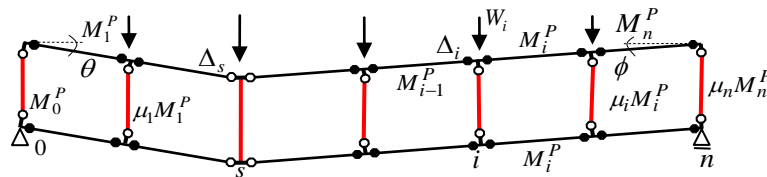

Figure 6. Parallel chord vierendeel girder of uniform strength under nodal loading

3.1 Theoretical development

Consider the collapse mechanism of Figure 6, where due to the development of  $4(n-1)$  inactive plastic hinges along the chords of the structure the girder tends to fail through a state of over complete collapse with only two sets of active plastic hinges along the chords of the structure. The inactive hinges are shown as black solid circles. For the sake of simplicity the effects of joint offsets  $\alpha$  and  $\beta$  have been omitted from the forthcoming discussions.

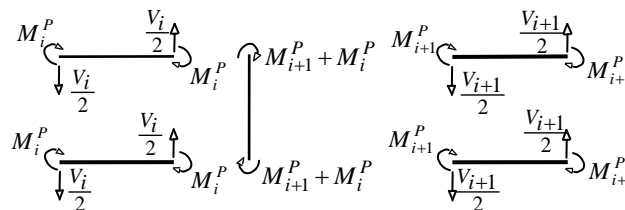

Figure 7. Free-body diagram of members of bays  $i$  and  $i+1$  (axial forces not shown for clarity)

An examination of the forces acting on the free body diagrams of bays  $i$  and  $i+1$  at incipient collapse, Figure 7, reveals that the sum of the plastic end moments of resistance of the  $i^{th}$  chord may be expressed as;

$$M_i^P = \frac{V_i L_i}{4} \text{ for } i = 1, 2, \dots, 3 \tag{31}$$

and that the end moments of the  $i^{th}$  vertical may be computed as  $\mu_i = |(M_{i+1}^P + M_i^P) / M_i^P|$ , or as;

$$\mu_i = \left| 1 + \frac{V_{i+1}}{V_i} \right| \tag{32}$$

3.2 Regular, uniform strength parallel chord VG of US under single Point load

A comparison of the collapse modes of VG of UX, Figure 2 and US, Figure 6 shows that two systems respond entirely differently under the same type of loading. In VG of UX analysis leads to the determination of the ultimate moments of resistance, whereas in VG of US the pre-assigned distribution of the moments of resistance controls the performance of the system at incipient collapse. More over, since the entire static solution of the VG of US is contained in Eqs. (31) and (32), the computational effort becomes independent of elaborate virtual work

analysis. In other words, the problem essentially becomes that of solving a structurally determinate system. Therefore, considering the postulated collapse mode of the girder under consideration as presented in Figure 8, the distribution of the plastic moments of resistance of

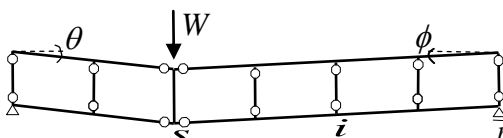

Figure 8. Regular uniform strength parallel chord vierendeel girder under point load

the members of the chords may be expressed directly as;

$$M_i^P = \left[ \frac{(n-s)}{n} - \langle i-s \rangle^0 \right] \frac{WL}{4} \tag{33}$$

where, the step function  $\langle i-s \rangle^0 = 0$ , for  $i \leq s$ , and  $\langle i-s \rangle^0 = 1$  for  $i > s$ . Since  $\mu_0 = \mu_n = 1$  then the distribution of plastic end moments of the vertical members may be summarized as the absolute value;

$$\mu_i = \left| \frac{2(n-s) - n[\langle i-s \rangle^0 + \langle i-s+1 \rangle^0]}{(n-s) - n \langle i-s \rangle^0} \right| \tag{34}$$

### 3.2.1 Example 7

The purpose of this example is to demonstrate how to generate a VG of US using Eqs. (31) and (32). Given;  $n=6, L=h, s=2, \alpha = \beta = 0$ . Determine  $\mu_i$  such that the subject VG acts as a structure of US.

*Solution:* From Eq. (33),  $M_1^P = WL/6$  and  $M_2^P = M_3^P = WL/12$ . We know that;  $\mu_0 = \mu_6 = 1$ . Eq. (34) gives upon substitution  $\mu_1 = 2, \mu_2 = 1/2$ , and  $\mu_3 = \mu_4 = \mu_5 = 2$ . This implies that the strength of all members of the VG can be expressed in terms of a single variable  $M^P = WL/6$ , i.e.,  $M_1^P = M_2^P = M^P, M_3^P = M_4^P = M_5^P = M_6^P = M^P/2$ . Similarly the required strengths of the vertical elements may be expressed as  $N_0^P = M^P, N_1^P = 2M^P, N_2^P = M^P/2, N_3^P = N_4^P = N_5^P = M^P$  and  $N_6^P = M^P/2$ .

### 3.2.2 Example 8

Verify the validity of Eqs.(33) and (34).

*Solution:* Since  $\phi = s\theta/(n-s)$  and that the moments of resistance of the bays of the girder can be summarized as  $M_i^P = W(n-s)L/4n$  for  $1 \leq i \leq s$  and  $M_i^P = WsL/4n$  for  $s+1 \leq i \leq n$ ; then the generalized virtual work equation for the particular loading and failure mode, Figure8 may be expressed as;

$$W L s \theta = 4 \sum_{i=1}^s M_i^P \theta + 4 \sum_{i=s+1}^n M_i^P \phi = 4 \frac{W(n-s)L}{4n} s \theta + 4 \frac{W s L}{4n} (n-s) \phi = W L s \theta \quad (35)$$

Since all conditions of the uniqueness theorem are satisfied the solution is valid and exact.

3.2.3 Example 9

Compare the weight efficiencies of the VG of Examples 1 and 7.

*Solution:* Using a weight equation similar to (6) gives;

$G_{ideal,US} = \gamma M^P L [2(2 + 4 \times 0.5) + (1 - 0.1)(1 + 2 + 0.5 + 3 \times 1 + 0.5)] = 2.3833 \gamma W L^2$  as compared with  $G_{haunch,UX} = 2.9808 \gamma W L^2$  and  $G_{ideal,UX} = 4.0999 \gamma W L^2$  for the idealized haunch enhanced and regular VG of US.

3.3 Regular, uniform strength parallel chord VG of US under uniform loading

Figures 9a and 9b depict two admissible collapse mechanisms for the subject VG with even and odd numbers of bays respectively. However, because of symmetry only the solution for the left half of the girder is presented.

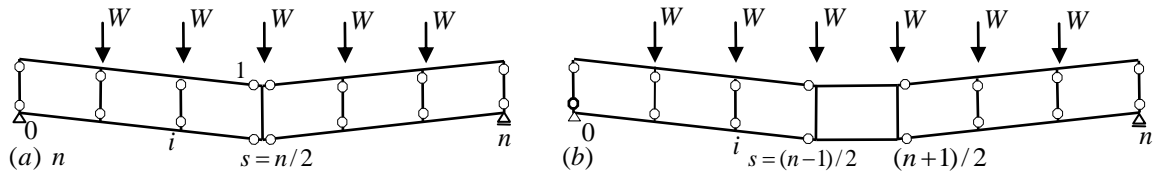

Figure 9. Regular Uniform strength parallel chord vierendeel girder under uniform loading, (a) Admissible failure mechanism for even number of bays, (b) Admissible failure mechanism for odd number of bays.

Following the general guidelines of the preceding section, the distribution of the plastic moments of resistance of the members of the VG of US may be expressed directly as;

$$M_i^P = (n + 1 - 2i) \frac{W L}{8} \quad (36)$$

$$\mu_i = \left| \frac{2(n - 2i)}{(n + 1 - 2i)} \right| \quad (37)$$

3.3.1 Example 10

Redesign the VG of UX of Example 5 as a VG of US, and compare the material consumption of the two solutions. Given;  $n=6, L=h, \alpha = \beta = 0$  and  $\partial_c = \partial_b = 0.1L$ .

*Solution:* From Eq. (36),  $M_1^P = M_6^P = 5W L / 8, M_2^P = M_5^P = 3W L / 8$  and  $M_3^P = M_4^P = W L / 8$ .



We know that;  $\mu_0 = \mu_6 = 1$ . Eq. (37) gives upon substitution;  $\mu_1 = \mu_5 = 8/5$ ,  $\mu_2 = \mu_4 = 4/3$ , and  $\mu_3 = 0$ . In other words, the strengths of all members of the VG can be expressed in terms of the single variable  $M^P = 5Wl/8$ , i.e.,  $M_1^P = M_6^P = M^P$ ,  $M_2^P = M_5^P = 3M^P/5$  and  $M_3^P = M_4^P = M^P/5$ . Similarly the required strengths of the vertical elements may be expressed as;  $N_0^P = N_6^P = M^P$ ,  $N_1^P = N_5^P = 8M^P/5$ ,  $N_2^P = N_4^P = 4M^P/3$  and  $N_3^P = 0$ . Next, using a weight equation similar to (27) gives;  $G_{ideal,US} = 2\gamma M^P L[(1+0.6+0.2)+(1-0.1)(1+1.6+1.33+0)] = 6.675\gamma WL^2$  as compared with  $G_{ideal,UX} = 12.66\gamma WL^2$  for the comparable VG of UX.

#### 4. CONCLUSIONS

The formulization of generalized, exact plastic analysis has remained one of the most challenging aspects of efficient VG design for several years. The essence of the paper is based on the novel failure mechanisms presented for the first time in this article.

An attempt has been made in the current article to revitalize the plastic design of VG by presenting them as two less generalized but practical categories of structural systems.

It was shown that for any VG of UX a relative strength factor could be found for which the total weight of the structure is a minimum. It was also demonstrated that VG of US are by default frameworks of absolute minimum weight.

It has been observed that racking moments can be utilized to conduct spot checks on final solutions. Further, it was shown that a small effort devoted to the detailing of the joints can lead to significant savings in total materials consumption.

Several generic examples were provided to demonstrate the validity and applications of the proposed formulations. The proposed formulae are theoretically exact and are best suited for preliminary, manual as well as spreadsheet computations.

#### REFERENCES

1. Davison B. Owens G. *The Steel Designers Manual*. 7<sup>th</sup> Edn, (1993) 413-28. Wiley-Blackwell
2. Del Savio, A.A. Martha, L. F, De Andrade, S. A. L. Structural modeling of vierendeel beams with semi-rigid joints, *Proceedings of the XXVI Iberian Latin-American Congress on Computational Methods in Engineering, Brazil, 2005*
3. Hendry A. W. Plastic Analysis and Design of Mild Steel Vierendeel Girders. *The Structural Engineer*, **33** (1955), No.7.
4. Morovich A. P. *Applicability of Plastic Design to the Vierendeel Trusses*. Tulane University of Louisiana, 1958.
5. Nyzen J. A. *The Optimum Limit Design of a Vierendeel Truss by Computer*, Massachusetts Institute of Technology, Department of Civil and Sanitary Engineering, 1962.
6. Baker J.F, Hayman, J. *Plastic Design of Frames*, **1**(1969), p.206, Cambridge University

- Press.
7. Bruneau M. Uang, C.M, Whittaker A. *Ductile Design of Steel Structures*, Mc Graw Hill, 1997.
  8. Basha H.S. Goel S. C. Seismic Resistant Truss Moment Frames with Ductile Vierendeel Segment, *Report #UMCEE94-29, (1994), University of Michigan Department of Civil and Environmental Engineering, Ann Arbor, MI.*
  9. Goel S. C. Liao W. C. Bayat M. R. and Chao S. H. Performance-based plastic design method for earthquake resistant structures. *Struct. Des. Tall Spec. Build.*, **19**(1-2), (2010), 115–137.
  10. Grigorian M. On Diagrids of Vierendeel Girders. *Proc. IASS Symposium on Space Struct.* 7-3, (1972), 617, Tokyo, Japan.
  11. Wen F. D. Zhi Y. Z., Fu D.Y. Study on the static stability and the ultimate bearing capacity of vierendeel latticed shells. *Appl Mech Mater.* 2011; **94**(9), 868-878.
  12. Grigorian M. Grigorian C. Performance control: A new elastic-plastic design procedure for earthquake resisting moment frames, *J. Struct. Div. ASCE*, 2012; **138**(6), 812-21.
  13. Grigorian M. Grigorian C. An introduction to the methodology of earthquake resistant structures of uniform response, *Buildings*, 2012; **2**, 107-125.
  14. Grigorian M. An introduction to performance control for moment frames of uniform response under lateral loading, *Asian J. of Civil Engineering*, 2013; **14**(1), 123-143.
  15. Grigorian M. Grigorian C. An overview on Performance Control and Efficient Design of Lateral resisting moment Frames. *Int J. of High-rise Buildings*, **2** (2013) No.2, p.141-152
  16. Brandt A. M. *Criteria and Methods of Structural Optimization*, (1984) p.129, Cluver Academic Publishers, USA
  17. Grigorian M. Grigorian C. Performance control for seismic design of moment frames, *Journal of constructional steel research*, 2011; **67** (7), 1106-14.
  18. Hayman J. On the estimation of deflections in elastic plastic frames. *Proc. Inst. Civ. Eng.*, 1961; **19**, 89.
  19. Grigorian M. Grigorian C. Lateral displacements of moment frames at incipient collapse. *J Struct Eng*, 2012; **44**, 174–185.
  20. Baker J.F. Horne M. R. Hayman J. *The Steel Skeleton*, Vols. **1-2** (1956), Cambridge Univ. Press
  21. Neal B. G. *The Plastic Methods of Structural Analysis*. Chapman and Hall, 1963
  22. Hayman J. *Plastic Design of Frames*, Cambridge University Press, 1971
  23. Wong M.B. *Plastic Analysis and Design of Steel Structures*, Elsevier, 2009
  24. Foulkes J. Minimum weight design and the theory of plastic collapse. *Q. Appl. Math.*, 1953; **10**, 347–358.
  25. Foulkes J. The minimum-weight design of structural frames. *Proc. R. Soc. London Ser. A*, (1954) 223, 482–494.
  26. Beedle L. S. *Plastic Design of Steel Frames*, John Wiley & Sons, 1954