



DESIGN OPTIMIZATION OF RC FRAMES UNDER EARTHQUAKE LOADS

S. Gharehbaghi^a and M. J. Fadaee^{*,†,b}

^a *Department of Civil Engineering, Behbahan Branch, Islamic Azad University,
Behbahan, Iran*

^b *Department of Civil Engineering, Shahid Bahonar University of Kerman, Kerman, Iran*

ABSTRACT

This paper deals with the optimization of reinforced concrete (RC) structures under earthquake loads by introducing a simple methodology. One of the most important problems in the design of RC structures is the existing of various design scenarios that all of them satisfy design constraints. Despite of the steel structures, a large number of design candidates due to a large number of design variables can be utilized. Doubtless, the economical and practical aspects are two effective parameters on accepting a design candidate. As such, in this paper the conventional design process that uses a trial and error process is replaced with an automated process using optimization technique. Also, the cost of construction is selected as an objective function in the automated process. A real valued model of particle swarm optimization (PSO) algorithm is utilized to perform the optimization process. Design constraints conform to the ACI318-08 code and standard 2800-code recommendations. Three ground motion records modified based on Iranian Design Spectrum is considered as earthquake excitations. Moreover, to reveal the effectiveness and robustness of the presented methodology, for example, a three-bay eighteen-story RC frame is optimized against the combination of gravity and earthquake loads. The entire process is summarized in a computer programming using a link between MATLAB platform and OpenSEES as open source object-oriented software.

Received: 7 August 2012; Accepted: 11 October 2012

KEY WORDS: optimization; RC frame; earthquake loads; particle swarm optimization; construction cost

* Corresponding author: M. J. Fadaee, Associate Professor, Department of Civil Engineering, Shahid Bahonar University of Kerman, Kerman, Iran

†E-mail address: mjfadaee@mail.uk.ac.ir

1. INTRODUCTION

Over the past two decades, structural optimization has been paid attention extensively by researchers. The problem has its origin in the fact that human tends to build the structures with minimum cost and resistant against natural hazards. Generally, when the number of structural elements increases, because of the increase in indeterminacy effects, obtaining the arbitrary design candidate is failed by means of a trial and error process. Hence, it is necessary to make a comprehensively intelligent exploration in order to find the optimum design candidate. Recently, in the most of engineering optimization problems, mathematical-based optimization methods considered as the certain methods, have been replaced with random methods. Random methods comprise the random sampling into the exploration space or random models of objective function. One of the important merits of such methods is the ability to obtain global optimum point. The certain methods have a basic problem namely cessation of the primary local optimum points [1]. Accordingly, researchers in the field of engineering optimization have studied the algorithms that are able to reach the vicinity of global optimum point. Among the optimization algorithm based on random sampling, it can be referred to as Genetic Algorithm (GA), Particle Swarm Optimization (PSO) algorithm, Ant-Colony (AC) algorithm, Harmony Search (HS) algorithm, Gravity Search Algorithm (GSA), Firefly Algorithm (FA) and so forth that have extensively been applied to the optimization of civil engineering problems.

Generally, in addition to the stability and resistance factors, another most important factor in seismic design of structures especially RC building is the economical factor of designing. Based upon the presented works in the literature, many studies have been carried out so as to the design optimization of steel structures while the small portion of the works have been studied on the optimization of RC structures. In spite of the steel structures, in rational design process of RC structures, the large number of design candidates can be found due to the large number of design variables such as cross-section dimension, number of reinforcements and their diameters. Thus, the problem can be solved using an automated search to optimum design candidate.

As noted previously, many series of algorithms were proposed in the literature that can be applied to achieve an appropriate design candidate called optimum design. In this paper, the real valued model of Particle Swarm Optimization (PSO) is utilized as the evolutionary algorithm to achieve the optimum design of RC frames. Recently, Gholizadeh and Salajegheh [2], Gharehbaghi and Salajegheh [3], Gharehbaghi *et al.* [4], Khatibinia *et al.* [5] reported the successful application of the real valued model of the PSO algorithm.

2. OBJECTIVES

During the past two decades, following recent developments in the field of design optimization of RC structures, a number of researchers have employed mathematical and evolutionary search techniques to optimum design subject to combination of gravity and lateral loadings. Krishnamoorthy and Munro [6] used linear programming techniques to optimize reinforced concrete frames. Moharrami and Grierson [7] presented an automated

computer-based method to design optimization of RC building frameworks. The optimally criteria (OC) method was applied to minimize the cost of concrete, steel, and formwork subject to constraints on strength and stiffness. Fadaee and Grierson [8, 9] optimized three dimensional RC frames in two cases, with and without shear wall against static loads using the OC method. Val *et al.* [10] used several iterative methods to evaluate the reliability of RC frames. Balling and Yao [11] optimized three-dimensional RC frames using a multilevel method in which the problem was separated into a system optimization problem and a series of individual member optimization problems. In their study, Non-Linear Programming (NLP) technique was employed for solving the continuous optimization problem for beams, columns and shear wall components. A GA-based methodology was presented by Rajeeve and Krishnamorty [12] to design optimization of RC frames. Such aspects as detailing and placing of reinforcement for beams and columns and also other factors of construction were considered into the design optimization process. The major idea behind the work was to fill the gap between theoretical results of optimum design due to continuity of design variables and practical aspects. Camp *et al.* [13] implemented GA algorithm to optimum flexural design of simply-supported beams, uniaxial columns, and multi-story frames by using a search for discrete-valued solutions of members in RC frames. Lee and Ahn [14] optimized RC plane frames against the combination of gravity and lateral loads. In their work, GA was utilized as an evolutionary algorithm in the framework of a discrete optimization problem. Also, the simple and idealized P-M interaction curve was presented to the control of column capacity under applied loads. Guerra and Kiousis [15] also presented a methodology to optimum design of multi-bay multi-story RC frames. They utilized an optimal stiffness correlation among structural elements. Generally, the process was carried out using a NLP algorithm to search the minimum cost solution. Moreover, code recommendations to design of structural elements under axial and flexural static loads were considered. Kwak and Kim [16] also optimized RC plane frames by considering two stages. At first, the pre-determined section database of beams and columns that were sorted based on section properties such as dimensions, reinforcement, axial and moment capacities, was constructed. Then, to accelerate the process of design optimization, the regression equations based upon the relation between the section identification number and section resisting capacity derived to obtain the continuous solution. In fact, the equation was employed to solve the optimization problem using mathematical programming. More recently, Kaveh and Sabzi [17] presented the application of two algorithms: heuristic big bang-big crunch (HBB-BC) and a heuristic particle swarm-ant colony optimization (HPS-ACO) to discrete optimization of reinforced concrete planar frames subject to combinations of gravity and lateral loads. Additionally, it can be referred to some other works related to optimization of RC frames [18-20].

3. OBJECTIVE AND SCOPE

The objective of this research is to design of low-cost RC frames by introducing a simple methodology schematized in framework of optimization problem. The constraints of proposed optimum design conform to the limitations and specifications of the American Concrete Institute (ACI) Building Code and Iranian Code of Practice for Seismic Resisting

Design of Buildings (Building and Housing Research Centre) called, 2800-code [21, 22]. By taking a glance at literature, it is recognized that in the most of the works, the optimization of RC frames have been accomplished under the combination of gravity and equivalent static lateral loads. In this study, RC frames are optimally designed under the combination of gravity and time-history earthquake loads. In this study, the control of design constraints is performed to accept the maximum and in fact critical condition of beam and columns elements during time-history earthquake loads. Especially, about the control of the capacity of column elements, it should be controlled the critical condition of axial load and bending moment as time history. In order to achieve this, in this paper, the combination of axial load and bending moment is checked at each step of ground motion records. In this regard, a simple process is introduced. Three ground motion records also modified based on Iranian Design Spectrum are considered as earthquake excitations.

In the case of RC structures, however, three cost components due to concrete, steel reinforcement and formwork are to be considered. Consequently, the cost of construction chosen as the objective function of optimization procedure includes all of the three cost components. As a case study, a three-bay eighteen-story RC frame is optimally designed to demonstrate the efficiency of the proposed methodology in line with the cost optimization of RC frames under earthquake loads.

4. OPTIMIZATION PROCEDURE

4.1. Formulation of optimization problem

Generally, an optimization problem can be divided into two groups: (1) constrained problems and (2) unconstrained problems. It is noted that because of the existing of various constraints so as to the control of stresses, deformations and also the cost of required materials, structural optimization problems deal with constrained problems. A constrained optimization problem is expressed as follows:

$$\text{Minimize: } f(X)$$

$$\text{Subject to: } g_i(X) \leq 0.0, \quad i = 1, 2, \dots, m \quad (1)$$

$$X_j \in R^d, \quad j = 1, 2, \dots, n$$

where $f(X)$ represents the objective function, $g_i(X)$ is the behavioral constraint, m and n are the number of constraints and the design variables, respectively; R^d is a given set of discrete values from which the design variables X_j take values. In the present study, to convert the constrained structural optimization problem into unconstrained one, an exterior penalty function method is used by constructing a function as the following form:

$$\Phi(X, r_p) = f(X) + r_p \sum_{i=1}^m [\max\{(g_i(X)/\bar{g}_i(X)) - 1, 0\}]^2 \quad (2)$$

where Φ and r_p are the pseudo objective function, and positive penalty parameter, respectively [23-25].

In sizing optimization, the object is typically to minimize the structural weight or the construction cost of structure, under some constrains. In this paper, the construction cost of structure is considered as an objective function articulated as:

$$CCost = \sum_{i=1}^{N_e} (C_c A_{ci} L_i + C_s A_{si} L_i + C_f A_{fi} L_i) \tag{3}$$

where $CCost$ represents the construction cost considered as objective function. Also, C_c and A_{ci} are the cost per unit volume and total area of the cross-section of i th element related to concrete, respectively; C_s and A_{si} are the cost per unit volume and area of steel bars in the cross-section of i th element; C_f and A_{fi} are also the cost per unit area of form-work and its area in the cross-section of i th element; and L_i is the length of i th element.

4.2. Problem constraints

In sizing optimization problems of structures, design criteria are applied as the problem constraints. In the paper, the design criteria encompass three set of constraints. The first set of constraints is related to the practical aspects and preliminary cross-section conditions. The second set is the constraints employed to capacity of beam and column elements in accordance with the code recommendations to design of RC structures against the combination of gravity loads. The last set is the constraints related to the capacity of beam and column elements based upon the code recommendations to resist the time-history earthquake loads including gravity loads and satisfy seismic provisions. More information of all three sets of constraints is uttered in the following sub-sections.

4.2.1 The first set of constraints

In order to design the structural elements, the constraints are considered based on ACI318-08 design code [35]. These constraints are expressed as fallowing limitations:

$$\rho_{min} = \max \left(\frac{1.4}{f_y}, \frac{0.25 \sqrt{f_c}}{f_y} \right) \leq \rho_{beam} \leq \rho_{max} = (0.75(0.85\beta_1) \frac{f_c}{f_y} \frac{E_s \epsilon_{cu}}{E_s \epsilon_{cu} + f_y}) \tag{4}$$

$$1\% \leq \rho_{col} \leq 4\% \tag{5}$$

$$ds = \frac{b - 2 \text{ cover} - 2 d_{bt} - N_{bl} d_{bl}}{N_{bl} - 1} \geq ds_{all} \tag{6}$$

$$\{b_{beam}^{top}, h_{beam}^{top}, n_{b\text{beam}}^{top}, A_{s\text{beam}}^{top}\} \leq \{b_{beam}^{bot}, h_{beam}^{bot}, n_{b\text{beam}}^{bot}, A_{s\text{beam}}^{bot}\} \tag{7}$$

$$\{b_{col}^{top}, h_{col}^{top}, n_{bcol}^{top}, A_{scol}^{top}\} \leq \{b_{col}^{bot}, h_{col}^{bot}, n_{bcol}^{bot}, A_{scol}^{bot}\} \quad (8)$$

ρ_{col} , ρ_{beam} , ρ_{max} and ρ_{min} represent the reinforcement percent (steel ratio) of cross-section of columns, the reinforcement percent of cross-section of beams, the maximum minimum reinforcement percent of cross-section of beams, respectively; b , d_{bt} , d_{bl} and N_{bl} are width of cross-section, diameter of transverse bars, diameter and number of longitudinal bars, respectively; Also, in equations (7) and (8) b , h , n_b , and A_s with the *top* and *bot* indices are the width, depth, number of longitudinal bars and total area of longitudinal bars for beams and columns which are in same direction between two series story, respectively. ds and ds_{all} are the distance among of side by side of longitudinal bars and its allowable value. The value of ds_{all} for columns and beams is defined as follows:

$$ds_{all} = \begin{cases} \max \{25mm, d_{bl}, 1.33 d_{max}\}; & \text{for Beams} \\ \max \{40mm, 1.5 d_{bl}, 1.33 d_{max}\}; & \text{for Columns} \end{cases} \quad (9)$$

where d_{max} is the diameter of greatest aggregate of concrete.

4.2.2 The second set of constraints

The second set of constraints is considered for controlling of capacity of beam elements against the combination of gravity loads. For this purpose, equation (10) is employed the following inequality:

$$M_u^b \leq \phi_b M_n^b \quad (10)$$

in which M_u^b , M_n^b and ϕ_b are the externally applied moment due to gravity loads, nominal flexural strength and strength reduction factor for beams, respectively. The value of ϕ_b is equal to 0.9.

To check the capacity of column elements under gravity loads, the combination of axial load and bending moment applied to the cross-section of column should be controlled. As mentioned previously, the idealized P-M interaction curve with characterized points that have been shown in Figure 1 was introduced in the literature. More details on the characterized points can be found in Ref [14]. In this paper, the idealized P-M curve is also utilized for controlling of columns capacity. Based on this curve, it can be written:

$$L_{OA} \leq L_{OB} \Rightarrow \sqrt{(M_u^c)^2 + (P_u^c)^2} \leq \sqrt{(\phi_c M_n^c)^2 + (\phi_c P_n^c)^2} \quad (11)$$

where M_u^c , M_n^c , P_u^c , P_n^c and ϕ_c are the externally applied moment due to gravity loads,

nominal flexural strength, externally applied axial force caused by gravity loads, nominal axial strength and strength reduction factor for columns, respectively. The values of φ_c are varied from 0.65 to 0.9.

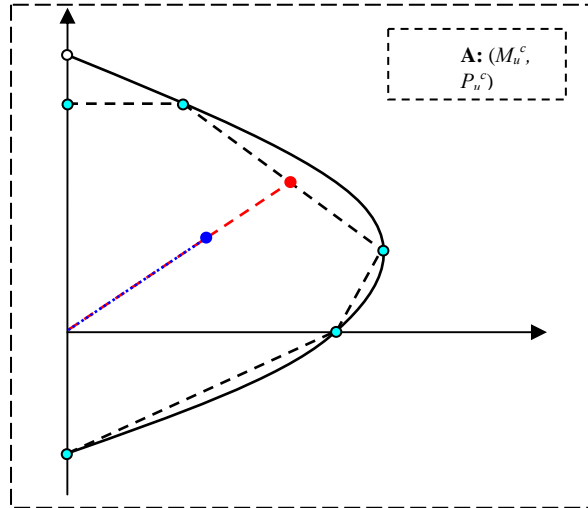

Figure 1: Original and Idealized P-M interaction curve [14]

The constraints expressed in the forms of (10) and (11), as well, should be checked for dynamic effects due to earthquake loads. Since an earthquake load is applied to the structures as time history, the capacity of beam and column elements should be checked for critical conditions. In the case of beam elements, the critical condition is defined as the maximum of externally applied moment during time-history loads. Also, in case of column elements, the critical condition is devoted to the critical combination of axial load and bending moment applied to cross-section that can be defined as a function depending on time. Accordingly, (10) and (11) can be generalized for beam and column elements respectively, as follows:

$$\max(M_u^b(t)) \leq \varphi_b M_n^b \tag{12}$$

$$\max(L_{OA}(t) / L_{OB}) \leq 1.0 \Rightarrow \max(\sqrt{(M_u^c(t))^2 + (P_u^c(t))^2} / \sqrt{(\varphi_c M_n^c)^2 + (\varphi_c P_n^c)^2}) \leq 1.0 \tag{13}$$

in which, t is the time of ground motion record. It is evident that the maximum combination of axial load and bending moment at columns called critical conditions should not be considered by the combination of the maximum of bending moment and the maximum of axial loads during earthquake simultaneously.

4.2.3 The third set of constraints

Generally, to design the structures, in addition to the control of preliminary conditions of cross-

section and the elements capacity, some limitations and specifications are considered according to the seismic provisions of the codes. Based upon ACI318-08 design code, the strong column-weak beam (SCWB) concept should be satisfied especially in seismicity zones by the following relationship:

$$SCWB (J_{i,j}) = [(M_c^t + M_c^b) / (M_b^l + M_b^r)]_{(i,j)} \geq 1.2 \quad (14)$$

in which M_c^t and M_c^b are the moment capacity of columns at the top and bottom of structural joint; also, M_b^l and M_b^r are the moment capacity of beams at the left and right of a structural joint. The inequality shall be satisfied for all of the structural joints ($J_{i,j}$) as shown in Figure 2. Hence, the restriction is considered as another constraint.

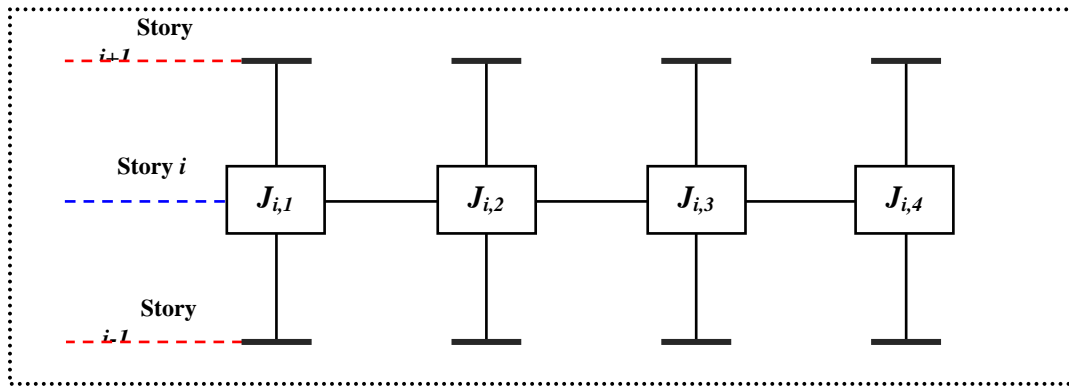

Figure 2. SCWB ratio for each structural joint at each story as ($J_{i,j}$)

On the other hand, one of the most important design constraints subjected to seismic loading is the inter-story drift ratio. The permissible ratio of the limitation is different depending upon the kind of structural analysis. In this paper, according to the recommendations of 2800-code, permissible values related to the constraint are considered as follows:

$$IDR : \begin{cases} IDR \leq 0.025 & \text{for } T < 0.7 \text{ sec} \\ IDR \leq 0.020 & \text{for } T > 0.7 \text{ sec} \end{cases} \quad (15)$$

where IDR and T , represent the inter-story drift ratio and the vibration period of structure, respectively. In this paper, it is assumed that the shear capacity of structural elements satisfies the code recommendations.

4.3. Optimization method

In this study, the (PSO) algorithm is utilized as an optimization method. The PSO has been inspired by the social behavior of such animals as fish schooling, insects swarming and birds flocking. The PSO was proposed by Kennedy and Eberhart [26] in the mid 1990s while

attempting to simulate the graceful motion of bird swarms as a part of a socio-cognitive study. It involves a number of particles initialized randomly in the search space of an objective function. These particles are referred to as swarm. Each particle of the swarm represents a potential solution of the optimization problem. The particles fly through the search space and their positions are updated based on the best positions of individual particles each iteration. The objective function is evaluated for each particle and the fitness values of particles are obtained to determine which position in the search space is the best [27]. In iteration k , the swarm is updated using the following equations:

$$V_i^{k+1} = w^k V_i^k + c_1 r_1 (P_i^k - X_i^k) + c_2 r_2 (P_g^k - X_i^k) \quad (16)$$

$$X_i^k = X_i^k + V_i^{k+1} \quad (17)$$

where X_i^k and V_i^k represent the current position and the velocity of the i th particle, respectively; P_i is the best previous position of the i th particle (called *pbest*) and P_g is the best global position among all the particles in the swarm (called *gbest*); r_1 and r_2 are two uniform random sequences generated from interval $[0, 1]$; w^k is the inertia weight used to discount the previous velocity of particle preserved. Shi and Eberhart [28] proposed that the cognitive and social scaling parameters c_1 and c_2 can be selected such that $c_1 = c_2 = 2.0$ to allow the product $c_1 r_1$ or $c_2 r_2$ to have a mean of 1. Each component of V_i is constrained to a maximum value defined as V_i^{\max} and a minimum value defined as V_i^{\min} .

A successful application of the binary model of PSO to time-history optimization was reported in [29]. In this paper, the real valued model of PSO that was used in Refs [2-5], is employed. In this model, the decimal values of the design variables are used in the optimization process instead of their binary codes. In this case, the length of the particles is shortened and therefore the convergence of the algorithm can be achieved with lower effort and higher speed.

4.4. Optimum design of RC structures

The main idea behind this paper is the design of low-cost RC structures to resist gravity and time-history earthquake loads. For this purpose, a methodology in the framework of an optimization problem is presented. Initially, two pre-determined section databases associated with essential properties of cross-sections of beam and column elements are prepared. Subsequently, by using the databases several RC structures are automatically modeled and analyzed against gravity and earthquake loads. After that, the mentioned design criteria considered as the constraints of optimization problem are checked. Finally, the process is iteratively performed to reach the optimum design.

In addition to creating the section pre-determined databases, to accelerate the optimization process and reduce the computational efforts, two main steps are adopted. Indeed, during the optimization process, after checking one set of constraints, in the case of satisfying this set, next step is performed. Corresponding to the two mentioned sets of

constraints, the two main conditional steps reduce the computational effort.

All of the process comprising the random configuration, modeling, analysis and check design of RC frames are summarized in a computer programming using a link between MATLAB [30] platform and OpenSEES [31] as open source object-oriented software. The presented methodology can be summarized as follows,

-
1. *Start by optimizer;*
 2. *Call of sections from pre-determined database;*
 3. *Devoting the sections to generate and modeling of the frame randomly;*
 4. *Control of equations (14-19);*
 5. *Computation of penalty function;*
 6. *If penalty value equal to zero, go to next step, else, go to step 4 to check the other frames;*
 7. *Perform the static analysis under the combination of gravity loads;*
 8. *Control of equations (20 and 21);*
 9. *Computation of penalty function;*
 10. *If penalty value equal to zero, go to next step, else, go to step 4 to check the other frames;*
 11. *Perform the time-history analysis under the combination of gravity and earthquake loads;*
 12. *Control of equations (22-25);*
 13. *Computation of finally penalty function;*
 14. *Computation of objective function;*
 15. *Iterating the previous steps to each frames at each iteration;*
 16. *Choose the best random design and update other frame's section based on it;*
 17. *Iterating the steps (3-15) in next iteration until the obtaining of the optimum design;*
 18. *End;*
-

5. NUMERICAL EXAMPLES

5.1. Frame geometry and pre-determined section database

To demonstrate the efficiency and robustness of presented methodology, for example, three-bay eighteen-story RC frame is considered to resist the combination of gravity and earthquake loads. As shown in Figure 2, the beam and column elements are separately classified using a group number as G01 to G15. The length of beams and the height of columns that are constant in each bays and stories are considered equal to 6.0 m and 3.3 m respectively. In the case of pre-determined section database, as noted earlier, two databases for beam and column elements are generated in which all of the essential section properties such as dimensions, reinforcement and so forth are located. The databases consist of several rectangular sections followed from ACI318-08 recommendations. In the case of beam sections, the width and height of sections are chosen from 400 to 450 mm and from 500 to 700 mm, respectively; and regarding the column sections, it is assumed that the width and

height of sections to be the same and are selected between 550 and 750 mm.

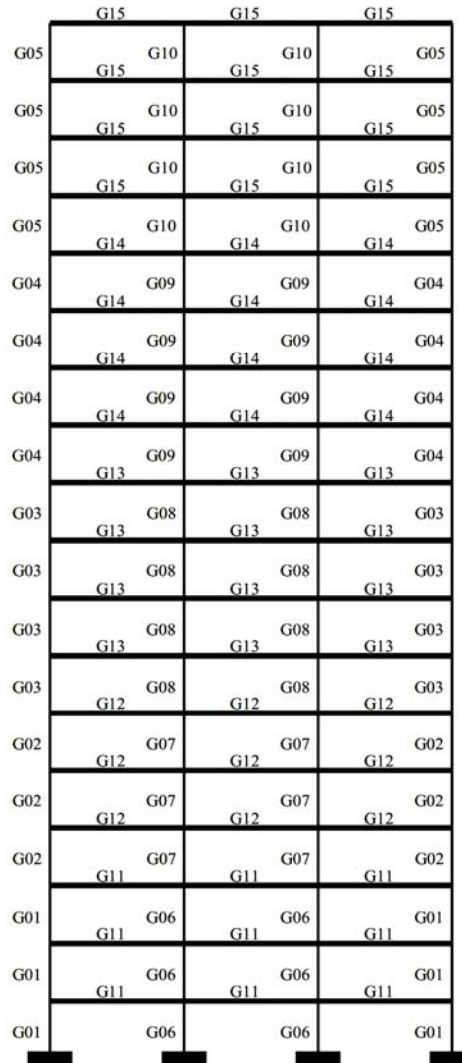

Figure 3. Geometry and group number of three-bay eighteen-story RC frame

Diameter of longitudinal bars is laid between 12 and 24 mm in the databases by the step of 2 mm; also, into the prepared databases, the difference between the dimensions of sequentially sections, 50 mm is considered. It is assumed that the transverse bars with 10 mm diameter are used for the shear control of the sections. The minimum concrete cover is also considered equal to 40 mm.

5.2. Modeling, loadings and analyses

The illustrated RC frame is modeled, loaded and analyzed using OpenSEES as open source object-oriented software. The *ElasticBeamColumn* element is used for modeling of beam and columns elements. In order to consider the effect of cracking, the moment of inertia of

the cross-section for each element is calculated by using the following equation [21, 22]:

$$I_{cracked} : \begin{cases} I_{cracked}^b = 0.35I_g^b \\ I_{cracked}^c = 0.70I_g^c \end{cases} \quad (18)$$

where $I_{cracked}^b$, $I_{cracked}^c$, I_g^b and I_g^c are the cracked moment of inertia of the section of the beam and column elements, the gross moment of inertia of the section of the beam and column elements, respectively. The ACI 318-08 code provides the elastic modulus of the concrete as $E_c = 4700\sqrt{f_c'}$ in *MPa*.

In case of loadings, it should be covered the required load combinations that have been provided by ACI 318-08 and 2800 codes. Related to the gravity and earthquake loads four load combinations are considered as:

$$\begin{aligned} Comb 1: & 0.9D \\ Comb 2: & 1.2D + 1.6L \end{aligned} \quad (19)$$

$$\begin{aligned} Comb 3: & 0.9D \pm 1.4E \\ Comb 4: & 1.2D + 1.0L \pm 1.4E \end{aligned} \quad (20)$$

in which, D , L and E , are the dead, live and earthquake loads acting on RC frame. In this study, the values of the dead and live loads are considered 5.884 N/mm^2 (600 kg/m^2) and 1.961 N/mm^2 (200 kg/m^2) for stories, 6.374 N/mm^2 (650 kg/m^2) and 1.471 N/mm^2 (150 Kg/m^2) for roof level. The introduced load combination in the (19) and (20) are applied to static and time-history analyses during the optimization process, respectively. In the case of earthquake loads, three original ground motion records, Imperial Valley 1940 (known as Elcentro), Kobe 1995 and San Fernando 1971 [32] are matched to Iranian Design Spectrum. According to the 2800-code, a site with relatively high seismic intensity and soil type III is selected. To match the records, SeismoMatch [33] software is used. One of the merits of the this software is match acceleration, velocity, displacement, energy, to their corresponding target parameters. The characteristics of original records are shown in Table 1.

Table 1. Some characteristics of three selected earthquake records

Earthquake	Station	Year	USGS class	PGA (g)	PGV (cm/s)	M
Imperial Valley	Elcentro	1940	C	0.31	29.8	6.5
Kobe	0 KJMA	1995	B	0.82	81.3	6.9
San Fernando	Pacoima Dam	1971	-	1.22	112.5	6.6

Besides, Figures 4-7 show the original records and their matched records, original response spectrums and their matched spectrum and also Iranian Design Spectrum. According to the intermediate ductility of RC moment resisting frames, the global response

modification factor (R-factor) is considered equal to 7.0. Likewise, the important factor of structure is assigned equal to 1.0.

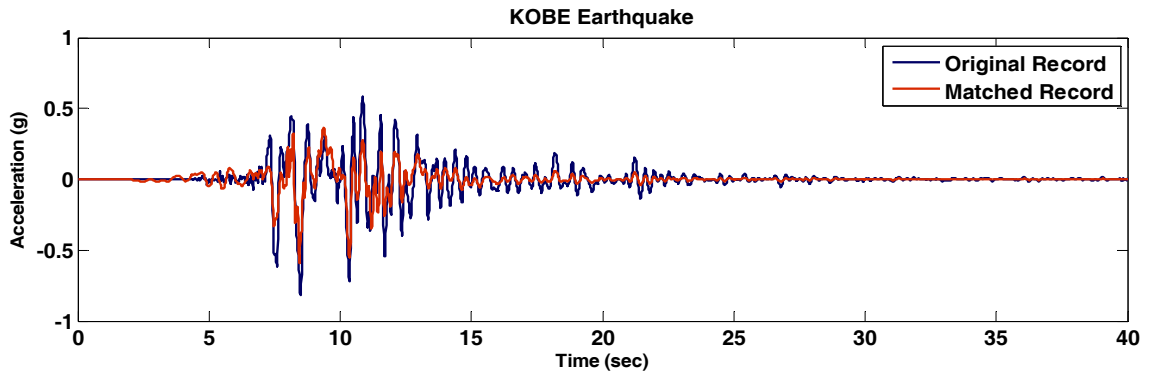

Figure 4. Original acceleration record of Kobe earthquake and its matched record to Iranian design spectrum (soil type III)

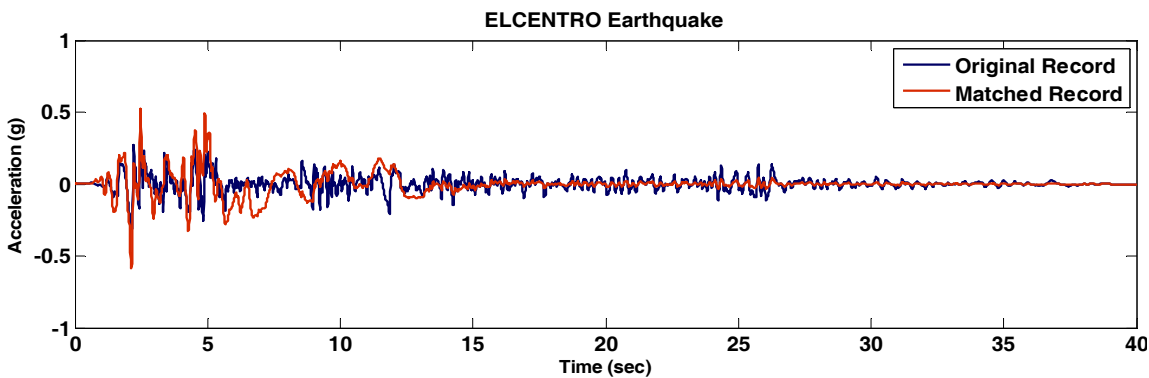

Figure 5. Original acceleration record of Elcentro earthquake and its matched record to Iranian design spectrum (soil type III)

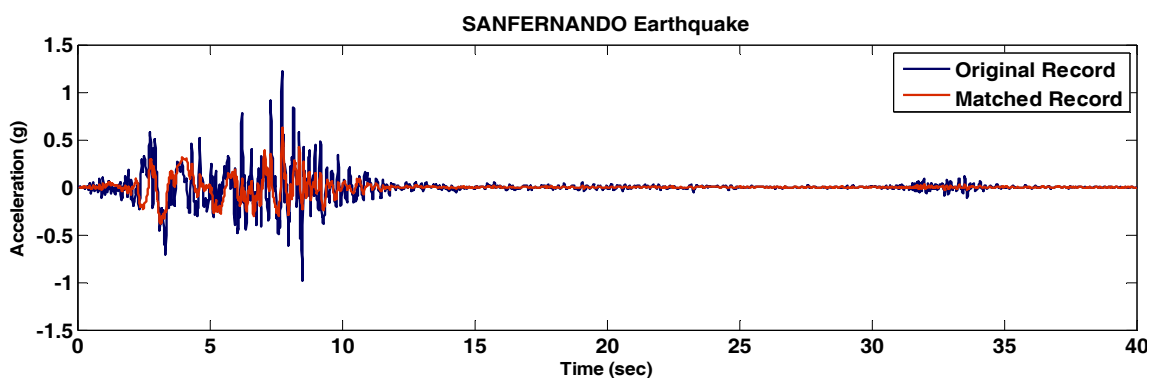

Figure 6. Original acceleration record of Sanfernando earthquake and its matched record to Iranian design spectrum (soil type III)

5.2. Construction cost units

In the case of RC structures, however, three cost components due to concrete, steel

reinforcement and formwork are to be considered. The cost of construction chosen as the objective function of optimization procedure consists of the three cost components. In this paper, the cost units of the construction components are considered based upon the works more recently presented by Kaveh and Zakian [34], $C_c = 60\$/m^3$, $C_s = 0.9\$/kg$, $C_f = 18.0\$/m^2$. It is assumed that the weight per unit volume of steel reinforcement to be equal to $\gamma_s = 7850kg/m^3$.

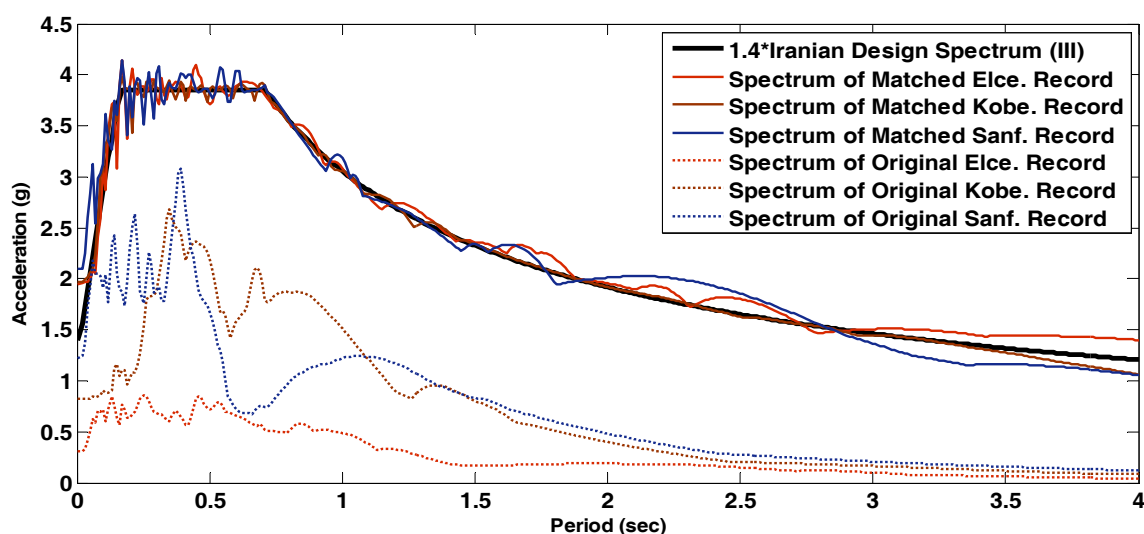

Figure 7. The spectrums of original acceleration and their matched records

5.2. Results and descutions

After the implementation of optimization procedure schematized in the automated step-by-step process using a link between DPSO code in MATLAB and OpenSEES, the optimum design of the frame has been obtained. The process has been performed by means of 20 particles as randomly design candidates. As the DPSO is not guaranteed to converge to the best result in a single run, a total of 10 DPSO runs have been conducted to arrive at the results. Then, the best run including the least value of objective function has been chosen. The average running time for one DPSO search is about 300 min on a desktop with Intel Core™ 2 Dou CPU T8300 and 4 GB random access memory. The convergence history of objective function has been depicted in Figure 6, and as shown, the automated process has been converged in 91th iteration. To reveal the efficiency and robustness of proposed automated design process, the results of initial and optimum design have been compared. Therefore, such most important parameters as the section dimensions and their reinforcement have been listed in Tables 2. Tables 3 and 4 also list the demand to capacity ratios (DCR) of beam and column elements and SCWB ratio of each structural joint, respectively.

As shown in Table 2, although only in a few cases the dimensions of columns has been changed and into the most of the sections the amount of reinforcement has been decreased. Because of the variations, in accordance with the minimum, maximum and average of DCR

ratios shown in the Table 3, the better use of the element's capacity and material in the case of optimum design has been occurred with respect to the initial design. In case of SCWB ratios, the results of initial design show that in several structural joints located in stories 4, 5, 6, 10, 14 and 18, the ratios is small than 1.2. The drawback has been eliminated during the optimization process and the optimum ratios have been coped with the shortcoming.

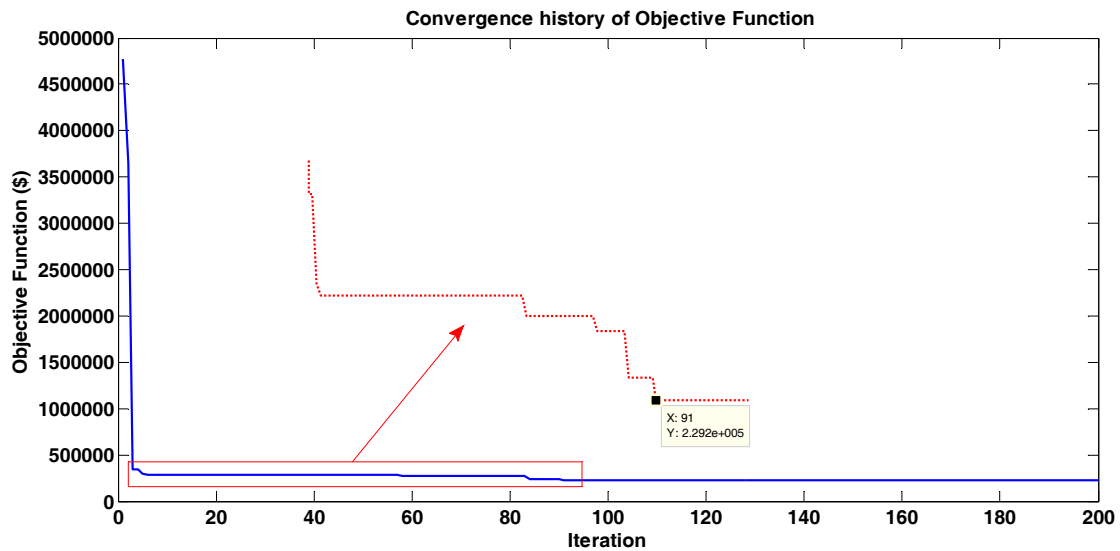

Figure 6. Convergence history of objective function

Table 2. A summary of section properties of initial and optimum design

Element type	Group Number	Dimensions (mm)				Reinforcement (%)	
		Initial		Optimal		Initial	Optimal
		Width	Height	Width	Height	Ratio	Ratio
Columns	G01	750	750	750	750	2.25	1.27
	G02	750	750	750	750	2.25	1.00
	G03	750	750	700	700	1.56	1.15
	G04	650	650	600	600	1.45	1.03
	G05	600	600	600	600	1.70	1.03
	G06	750	750	750	750	2.25	1.89
	G07	700	700	750	750	1.45	1.27
	G08	700	700	700	700	1.45	1.45
	G09	650	650	650	650	1.14	1.45
	G10	550	550	550	550	1.60	2.02
Beams	G11	450	650	450	650	2.47	1.72
	G12	450	650	450	650	2.47	1.72
	G13	450	650	450	650	2.08	1.72
	G14	400	600	400	600	1.90	1.27
	G15	400	500	400	500	2.28	1.53

Table 3. A summary of demand to capacity ratio (DCR) of elements in each story

Story Level	DCR (Beams)				DCR (Columns)			
	Initial		Optimal		Initial		Optimal	
	min	max	min	max	min	max	min	max
1	0.38	0.39	0.53	0.54	0.64	0.85	0.65	0.85
2	0.44	0.47	0.62	0.66	0.52	0.74	0.53	0.74
3	0.46	0.50	0.64	0.71	0.45	0.67	0.46	0.67
4	0.44	0.51	0.62	0.71	0.43	0.72	0.41	0.62
5	0.42	0.50	0.59	0.70	0.40	0.69	0.39	0.59
6	0.39	0.49	0.56	0.68	0.39	0.65	0.37	0.56
7	0.44	0.57	0.53	0.67	0.38	0.61	0.44	0.61
8	0.42	0.57	0.52	0.67	0.35	0.57	0.41	0.75
9	0.41	0.58	0.50	0.67	0.32	0.52	0.37	0.52
10	0.40	0.58	0.50	0.67	0.30	0.48	0.35	0.48
11	0.53	0.72	0.79	1.00	0.38	0.52	0.45	0.52
12	0.52	0.71	0.77	1.00	0.34	0.45	0.41	0.45
13	0.49	0.70	0.73	0.98	0.24	0.40	0.31	0.40
14	0.47	0.68	0.70	0.96	0.21	0.36	0.25	0.36
15	0.51	0.67	0.75	0.96	0.23	0.40	0.28	0.39
16	0.48	0.64	0.70	0.91	0.23	0.32	0.28	0.32
17	0.42	0.60	0.62	0.86	0.19	0.22	0.18	0.27
18	0.41	0.54	0.61	0.77	0.18	0.29	0.15	0.43
Min	0.38	0.39	0.5	0.54	0.18	0.22	0.15	0.27
Max	0.53	0.72	0.79	1.00	0.64	0.85	0.65	0.85
Average	0.44	0.58	0.63	0.78	0.34	0.52	0.37	0.53

Table 4. SCWB ratio for each joint at stories

Story i^{th}	SCWB ($J_{i,1}$)= SCWB ($J_{i,4}$)		SCWB ($J_{i,2}$)= SCWB ($J_{i,3}$)	
	Initial	Optimal	Initial	Optimal
1	4.22	3.44	1.98	2.37
2	4.24	3.46	2.00	2.39
3	4.26	3.12	1.54	2.02
4	4.28	2.78	1.07	1.66
5	4.30	2.79	1.08	1.67
6	3.68	2.69	1.09	1.61
7	3.61	2.58	1.29	1.54
8	3.63	2.59	1.30	1.56
9	3.64	2.60	1.32	1.57
10	2.90	2.02	1.08	1.41
11	3.17	2.58	1.22	2.23
12	3.19	2.60	1.24	2.26
13	3.21	2.61	1.25	2.28
14	3.07	2.63	1.14	2.07
15	3.74	3.36	1.31	2.36
16	3.76	3.38	1.33	2.40
17	3.78	3.40	1.34	2.43
18	1.90	1.71	0.68	1.22

Above all, in addition to the structural performance, in terms of economical aspects, the construction cost of the design has been investigated. The cost of each component applied in the construction has been given in Table 5.

Table 5. A comparison between the components cost of initial and optimum design

Elements Type	Component Cost	Cost (\$)	
		Initial	Optimal
Beams	Concrete	4947.28	4979.13
	Steel	130030.48	93165.47
	Formwork	12052.80	12052.80
Columns	Concrete	6528.47	6426.68
	Steel	131039.28	101073.97
	Formwork	11618.69	11499.84
Total		296217	229198

To compare between the initial and optimal design, the main factors affecting construction cost are the costs of concrete and steel reinforcement in all of the elements. As a result, the construction cost of optimum design has significantly been decreased using the introduced optimization process.

6. CONCLUSION

In this paper, an automated procedure was presented to design optimization of RC structures under the time-history earthquake loads. The construction cost was regarded as an objective function of the defined optimization problem. The design criteria called optimization constraints were selected and classified in three sets, primary allowable section conditions, capacity criteria and seismic provisions in accordance with the ACI318-08 and 2800 codes. To check the capacity of columns elements under static loads, an idealized P-M interaction curve that was presented in the literature was used and generated to accept the columns elements under time-history earthquake loads. The real valued model of PSO algorithm was employed to intelligent exploration into the search space of design candidates. On the other hand, as earthquake excitations, three real ground motion records were chosen and matched to Iranian Design Spectrum with soil type III. Finally, after the implementation of optimization process on a three-bay eighteen-story RC frame, the optimum design was obtained. The optimum results reveal that by using the automated design process, it can be achieved a design candidate associated with the minimum construction cost that conforms to the standard codes provisions.

REFERENCES

1. Rao SS. *Optimization: Theory and Applications*, John Wiley & Sons, New Delhi, 1984.
2. Gholizadeh S, Salajegheh E. Optimal design of structures for time history loading by Swarm intelligence and an advanced metamodel, *Comput Meth Appl Mech Eng*, 2009;

- 198**: 2936–49.
3. Gharehbaghi S, Salajegheh E. Optimum distribution of hysteretic energy in RC structures, *Proceedings of the 6th National Congress of Civil Engineering*, Semnan, Iran, 2011 (In Persian).
 4. Gharehbaghi S, Salajegheh E, Khatibinia M. Optimization of reinforced concrete moment resistant frames based on uniform hysteretic energy distribution, *Proceedings of the 1st International Conference on Urban Construction in the Vicinity of Active Faults*, Tabriz, Iran, 2011.
 5. Khatibinia M, Salajegheh J, Fadaee MJ, Salajegheh E. Prediction of failure probability for soil-structure interaction system using modified ANFIS by hybrid of FCM-FPSO, *Asian J Civil Eng*, 2012; **13**: 1-27.
 6. Krishnamoorthy CS, Munro J. Linear program for optimal design of reinforced concrete frames, *Proceedings of IABSE*, 1973; Vol. **3**: pp. 119–141.
 7. Moharrami H, Grierson DE. Computer automated design of reinforced concrete frameworks, *J Struct Eng, ASCE*, 1993; **119**: 2036-58.
 8. Fadaee MJ, Grierson DE. Design optimization of 3D reinforced concrete structures, *Struct Multidisc Optim*, 1996, **12**: 127–34.
 9. Fadaee MJ, Grierson DE. Design Optimization of 3D Reinforced Concrete Structures Having Shear Walls, *Eng Comput*, 1998; **14**: 139-45.
 10. Val D, Bljoger F, Yankelevsky D. Optimization problem solution in reliability analysis of reinforced concrete structures, *Comput Struct*, 1996; **60**: 351–35.
 11. Balling RJ, Yao X. Optimization of reinforced concrete frames, *J Struct Eng, ASCE*, 1997; **123**: 193–202.
 12. Rajeev S, Krishnamoorthy CS. Genetic algorithm-based methodology for design optimization of reinforced concrete frames, *Comput Aided Civ Infrastruct Eng*, 1998; **13**: 63-74.
 13. Camp CV, Pezeshk S, Hansson H. Flexural design of reinforced concrete frames using a genetic algorithm, *J Struct Eng, ASCE*, 2003; **129**: 105–15.
 14. Lee C, Ahn J. Flexural design of reinforced concrete frames by genetic algorithm, *J Struct Eng, ASCE*, 2003; **129**: 762-74.
 15. Guerra A, Kiouisis PD. Design optimization of reinforced concrete structures, *Comput Struct*, 2006; **3**: 313-34.
 16. Kwak HG, Kim J. Optimum design of reinforced concrete plane frames based on predetermined section database, *Computer -Aided Design*, 2008; **40**: 396-408.
 17. Kaveh A, Sabzi O. Optimal design of reinforced concrete frames Using big bang-big crunch algorithm, *Int J Optim Eng, IUST*, 2012; **10**: 189-200.
 18. Gharehbaghi S. Damage and energy concepts-based optimum seismic design of RC structures, MSc Thesis, Department of Civil Engineering, Shahid Bahonar University of Kerman, Iran, 2011 (In Persian).
 19. Kaveh A, Sabzi O. A comparative study of two metaheuristic algorithms for optimal design of planar RC frames, *Int J Optim Eng, IUST*, 2011; **9**: 193-206.
 20. Sharafi P, Hadi MNS, Teh LH. Heuristic approach for optimum cost and layout design of 3D reinforced concrete frames, *J Struct Eng, ASCE*, 2012; **138**: 853–63.
 21. American Concrete Institute (ACI 318-08). Building code requirements for structural

- concrete, 2008.
22. Standard No. 2800. Iranian code of practice for seismic resistant design of buildings, Building and Housing Research Center, 3rd Edition, 2007.
 23. Goldberg DE. *Genetic Algorithms in Search, Optimization, and Machine Learning*, Addison-Wesley publishing Co., Inc., Reading, Mass, 1989.
 24. Vanderplaats GN. *Numerical optimization techniques for engineering design with applications*, McGraw Hill, New York, 1984.
 25. Gholizadeh S. Optimal seismic design of structures by advanced artificial intelligence methods, Ph.D. Dissertation, Department of Civil Engineering, Shahid Bahonar University of Kerman, Iran, 2009 (In Persian).
 26. Kennedy J, Eberhart RC. *Swarm intelligence*, Academic Press, San Diego, California, 2001.
 27. Bergh V, Engelbrecht A. Using neighborhood with the guaranteed convergence PSO, *Proceedings of the 2003 IEEE Swarm Intelligence Symposium*, 2003, pp. 235-242.
 28. Shi Y, Eberhart RC. A modified particle swarm optimizer, *Proceedings of the IEEE International Conference on Evolutionary Computation*, 1997, pp. 303-308.
 29. Salajegheh E, Gholizadeh S, Khatibinia M. Optimal design of structures for earthquake loads by a hybrid RBF-BPSO method, *Earthquake Eng Eng Vib*, 2008; **7**: 14-24.
 30. MATLAB. The language of technical computing, Math Works Inc., 2010.
 31. OpenSEES. Open system for earthquake engineering simulation, Pacific Earthquake Engineering Research Centre, University of California, Berkeley, (Release 2. 3. 2), 2012.
 32. PEER Strong Motion Database, <http://peer.berkeley.edu/smcat/index.html>, 2012.
 33. SeismoMatch v1.3.0, <http://www.seismosoft.com>, 2012.
 34. Kaveh A, Zakian P. Performance based optimal seismic design of RC shear walls incorporating soil-structure interaction using CSS algorithm, *Int J Optim Civil Eng*, 2012; **2**: 383-405.