

The Effect of Temperature on the Purity of Nano-Scale Tantalum Powder Produced from Its Scrap by Reaction with Magnesium and Calcium

Gholam Hussein Borhani, Saeed Reza Bakhshi*, Sadegh Soltani

* bakhshsr@mut-es.ac.ir

Department of Materials Engineering, Malek-Ashtar University of Technology, Shahinshahr, Isfahan, Iran

Received: October 2020

Revised: January 2021

Accepted: February 2021

DOI: 10.22068/ijmse.2006

Abstract: In this study, Ta powder was produced from Ta scarp via chemical processes using Mg and Ca powders. Initially, tantalum scraps were converted to tantalum oxide (Ta_2O_5) at $1100^\circ C$ in an oxygen atmosphere. Tantalum oxide was then reduced to Tantalum powder with Mg in a vacuum environment at 950 to $1200^\circ C$ for 3 hours. The obtained Ta powders further were reacted with Ca at $950^\circ C$ for 5 hours in a vacuum atmosphere. The powders were analyzed using X-ray diffraction (XRD), scanning electron microscopy (SEM), as well as conducting oxygen content measurement. The results showed that the average particle size of the produced Ta powders was around 58 nm with oxygen contents of 250 ppm.

Keywords: tantalum, refractory metal, magnesium, recovery process, magnesiothermic reduction.

1. INTRODUCTION

Transition metals and their compounds exhibit high potential for industrial application due to their inherent metal-like properties as well as those like refractory materials [1]. Among them, Tantalum (Ta) belongs to the group of high-performance metals that have gained acceptance due to their several unique properties. Ta has a high melting point, good ductility along with high strength, good anti-oxidation properties, and also exhibits excellent thermal resistance [2]. The concave disc penetrators made with sintered fine Ta powders infilled with the used as a weapon in the military tend to increase the depth of penetrating [3]. Another application of Ta is as its carbide (TaC) which is used in cutting tools as well as in the catalyst manufacturing [4].

To fulfil the demand of Ta powder, many chemical methods have been adopted to synthesize it from $TaCl_5$ or K_2TaF_7 [5, 6]. In actual practice, it is difficult to synthesize pure Ta nanopowder. Traditionally, Ta metal powder has been produced by the reduction of potassium heptafluorotantalate (K_2TaF_7) with sodium [7]. The K_2TaF_7 is produced by hydrofluoric acid dissolution and purification from tantalite [(Fe, Mn) Ta_2O_5] ore [8]. The metallic Ta powder produced with this method is high quality, but the process itself is energy consuming, complicated, and also generates environmentally harmful

fluorides [8, 9]. The pure Ta powder can also be obtained by various methods like hydrogen arc plasma method [10], hydrogen reduction [2, 10], metallothermic reduction in the presence of magnesium [11-13], and calciothermic reduction [14] of Ta_2O_5 or $TaCl_5$ powders. But all these reduction processes are not too well suited for commercial production of Ta nanopowders because of high sensitivity to contamination, high reaction temperature, and lack of control for particle morphology as well as purity. This has led to the exploration for new synthesis routes which can simplify the processing steps and/or reduce the reaction temperature. Any such technique which can yield nanosized Ta powder will be highly useful for industrial applications. The high affinity of tantalum for interstitials presents serious problems in powder metallurgy; high interstitial contents typically limit formability and ductility compared to the ingot metallurgy tantalum. Oxygen has been the most important problem in powder metallurgy (PM) tantalum and the most studied over the past few decades [15]. Oxygen dramatically increases the hardness of tantalum [16, 17].

The purpose of this study is to develop an effective process for tantalum scrap recovery to high pure tantalum nanopowders with magnesiothermic reduction. To remove the remained oxygen from the produced tantalum powder, the secondary reducing method was examined using calcium reagent.

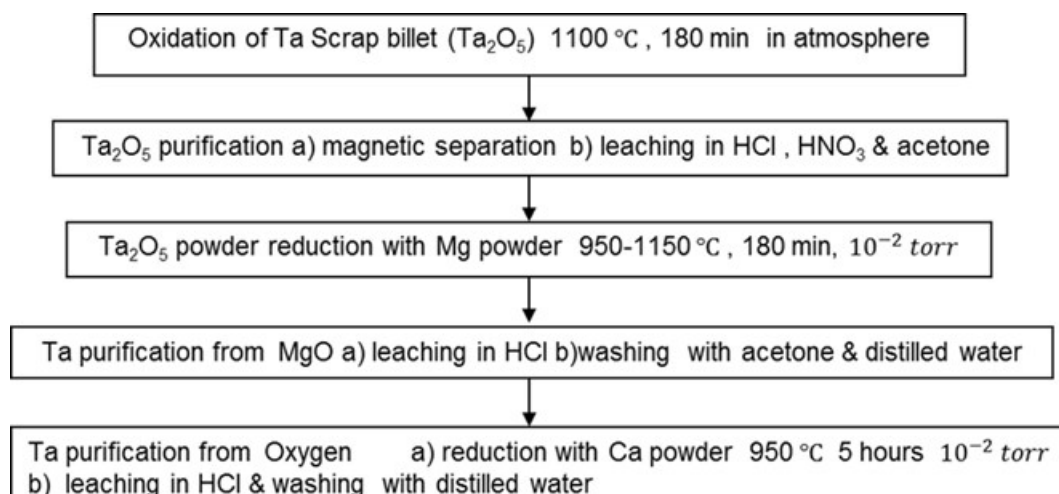

Fig. 1. Flowchart of Ta recovery process from Ta scraps using oxidation treatment.

2. EXPERIMENTAL PROCEDURE

Figure 1 shows the flowchart for tantalum recovering investigated in this work. It consisted of three major steps. The first step is involved the conversion of tantalum scrap billet to Ta_2O_5 powders and the second step is the recovery of Ta_2O_5 to Ta powder via conventional metallothermic reduction and leaching process. The third step is the refining of Ta powder from oxygen using calcium as a reducing agent.

To start the experimental produce, 100 g of Ta scraps were placed on a ceramic tray and then oxidized in the presence of oxygen at a temperature of 1100°C for a time of 180 minutes. To remove the iron contaminations, the dried powders were passed through magnetic separation. The obtained Ta_2O_5 powders were washed in nitric acid (65%), hydrochloric acid (37%) and acetone to dissolve metallic contaminations. A schematic diagram of the experimental apparatus for the magnesiothermic reduction of Ta_2O_5 was illustrated in Figure 2. Ta_2O_5 powder was placed in a stainless-steel vessel (10 g), and Mg powders were placed at the bottom of the vessel (approximately 2.7 g). The Mg was physically isolated from the Ta_2O_5 sample to prevent contamination. The Ta_2O_5 powder was fixed above the magnesium powders tray by a stainless-steel holder; then all is sealed in a reaction vessel (Figure 2). The temperatures of the system were varied from 950 to 1200°C for a fixed period of 3 hours in a vacuum atmosphere, to react the Ta_2O_5 powders with Mg vapour. The remained powders were furnace cooled (Eq. 1)

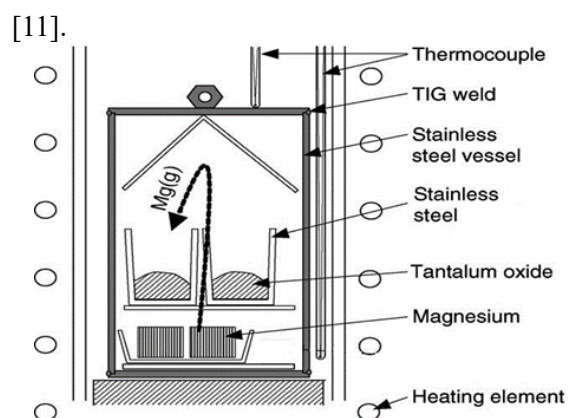
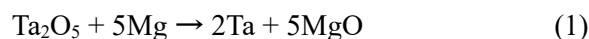
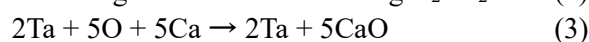
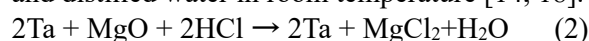

Fig. 2. Schematic of steps for Ta powder production.



The remained powder products were washed at least 5th time with HCl (37%) for 30 min via stirring at room temperature until Mg and MgO were reacted with the solution and separated from the Ta powder (Eq. 2). In the leaching process, the powders were thoroughly washed with acetone and distilled water (three times), in order to restore the recovered Ta powder free of any impurities. It should be noted that due to a high density of Ta (16.69 g/cc), it will be easily deposited in the bottom of water solution. Finally produced tantalum powders were dried at 100°C for 60 minutes. The dried powders were reacted with calcium powder at a temperature of 950°C for 4 hours in a vacuum atmosphere (Eq. 3). The CaO were removed from Ta by leaching in HCl and distilled water in room temperature [14, 18].



The powders were analyzed through X-ray diffraction patterns (Philips AW-XDM300). Microstructure and morphology analysis was performed with Tescan Mira3-XMU scanning electron microscopy. The oxygen content in the samples was measured using the LECO- TCH600 instrument.

3. RESULTS AND DISCUSSION

3.1. XRD Analysis

Figure 3 shows the XRD results of Ta scrap oxidation process; findings revealed that the peaks obtained after the review and further analysis with the X'Pert HighScore software were fully compatible with tantalum oxide according to reference model (01-071-0639) [2]. As it is observed in Figure 3, there was no additional peak indicating the complete transformation of tantalum to tantalum oxide with Ta₂O₅ chemical formula and orthorhombic crystalline structure.

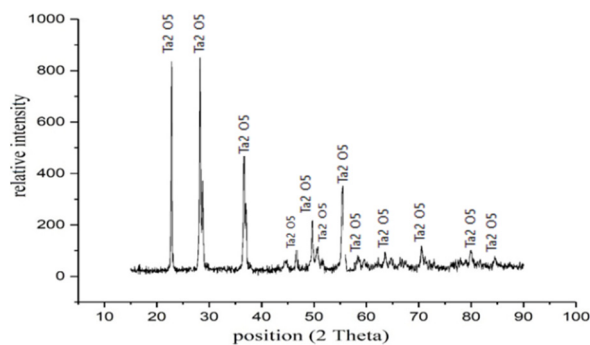

Fig. 3. X-ray diffraction patterns of Ta₂O₅.

The XRD patterns of Ta powder produced from Ta₂O₅ after thermal reduction at 950°C to 1200°C for 3 hours were shown in Figure 4. According to the XRD results in Figure 4, by increasing the reduction temperature from 1000 to 1200°C, some impurities have existed in Ta powders. These impurities are identified as hematite (Fe₂O₃) and magnetite (Fe₃O₄) which has existed during the reduction procedure in addition to the Ta powder.

The approximate quantities of these phases were calculated using MAUD software quantitative analyses. The percentages of present phases in tantalum powder were high at 1200°C as shown in Table 1. In the patterns A, B and C (Figure 4), heat recovery operation was reduced from 1200°C to 1100°C and 1000°C respectively to remove the impurities. Considering B and C and comparing to A, the impurities were relatively reduced. Yuan

et al. [11] explained the presence of impurities in Ta powder is due to some external sources. They also stated that the number of impurities in Ta powder had been fed through the furnace elements and the body of the recovery reactor. To reduce and correspondingly to remove these impurities from the reactor's body, the reduction temperature could be reduced to less than 1000°C.

Table 1. The MAUD software quantitative analysis from produced tantalum powders (wt %)

XRD Patterns (°C)	Ta	Fe ₂ O ₃	Fe ₃ O ₄	Total Iron	Total Oxygen
A (1200°C)	84	7.5	8.5	11.4	4.6
B (1100°C)	89	4.5	6.5	7.85	3.14
C (1000°C)	96	1.5	2.5	2.86	1.13
D (950°C)	100	0	0	-	-
F (950°C)	100	0	0	-	-

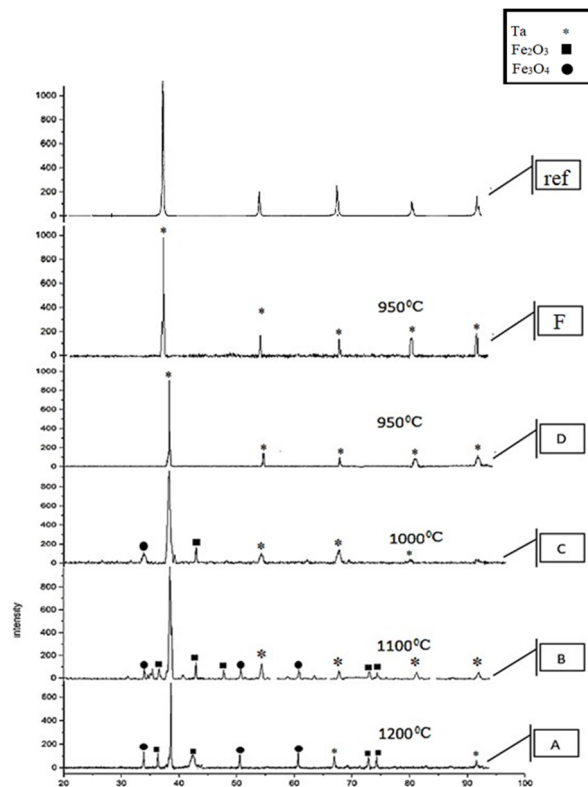

Fig. 4. X-ray diffraction patterns of the Ta powder produced at various temperatures.

The thermal recovery temperature was changed from 1000°C to 950°C (pattern D). It was observed that a complete transformation of Ta₂O₅ into the cubic structure of Ta had occurred at 950°C (Table 1) [19]. Hwang et al. [20] were

reported the behaviour of Ta reduction from Ta₂O₅ powders at different temperatures in the stainless steel reactor; they have not exceeded the reduction temperature more than 1223°K. The iron dissolution in Ta powder was about 983°C. This shows the reduction temperature at 950°C is an optimized value for the recovery of Ta₂O₅ powder over a period of 3 hours. According to the stoichiometry results for Ta₂O₅ decomposition, for each 10 g of Ta₂O₅, 8.24 g tantalum powder should be produced. The Ta powder produced after weighing was about 6.9 g, which was lower than its calculated values. These results show the efficiency of this reduction method is about 83% at 950°C.

Figure 4 shows the XRD results for the Ta powder after double reduction at 950°C (pattern F). The peaks are completely compatible with the standard Ta peak and as expected, there are no impurities in this XRD pattern. The efficiency of the said Ta powders with respects to the stoichiometry values is about 97%. The shift of peaks in XRD patterns (A to D), indicates some change in Ta lattice parameter. This change could be due to the presence of interstitial oxygen in Ta structure [21] but there is no shift of peak in XRD pattern F, for double refined produced Ta powders. The results show that the Ta powders which are further reduced with Ca are purer as the oxygen content has reduced to minimum values.

3.2. Oxygen measurements

Table 2 shows the quantitative analysis for oxygen content in produced Ta powder at different temperatures. The oxygen values are decreased as the reduction temperatures are decreased from 1200°C to 950°C. The amount of oxygen at 950°C was measured to about 2800 ppm. This high value of oxygen is due to the mechanism of reduction and the oxygen released from Ta₂O₅ decomposition is reacted with Mg and also iron in the system.

Table 2. Quantitative analysis for oxygen content at various temperatures

Number	Recovery Operation Temperature (°C)	Amount of Oxygen (ppm)
1	1200	14200
2	1100	8500
3	1000	6950
4	950	2800
5	950	250

The affinity of forming iron oxides above 980°C is more for MgO formation. The production of Fe₂O₃ and Fe₃O₄ were not completely dissolved during the leaching process. Therefore, the oxygen gross presence in Ta powder looks higher where the reduction temperature was reduced [8, 22] (Table 2). The process of double refining with calcium has caused CaO formation and consumed maximum oxygen. The oxygen content in Ta powder has reduced to less than 250 ppm which is the desired value in Ta processing route. These results are compatible with XRD results (Figure 4, pattern F) since there is no shift of peaks in that and all peak are in match with ref. pattern [11].

3.3. Morphological structures

The morphology as well as the particle size of the Ta₂O₅ in different magnifications was presented in Figure 5.

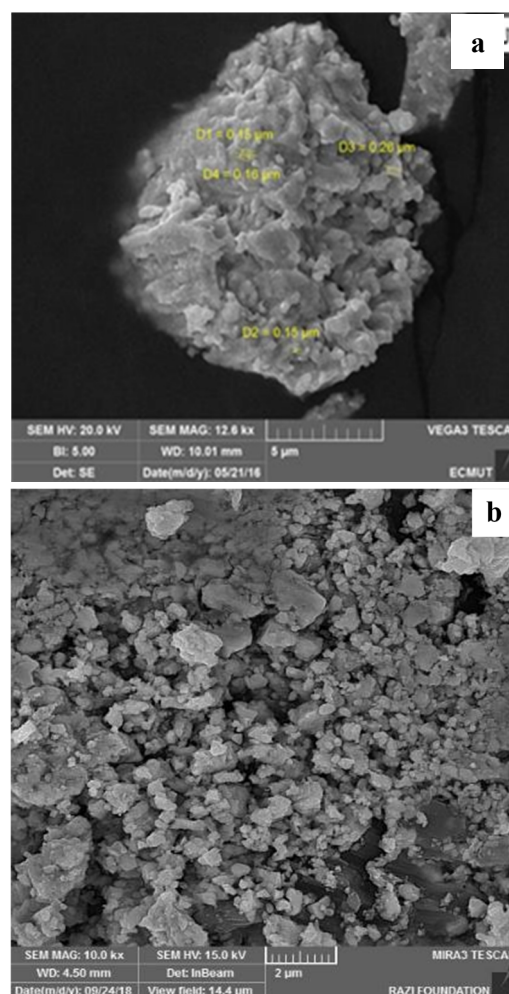

Fig. 5. The SEM morphology and particle size for produced Ta₂O₅ powder in different magnifications.

The particles are spherical with size variations

between 150 nm to 260 nm. This type of morphology is also observed by some other researchers [22]. According to the dimensions indicated in Figure 5, the average particle size was measured 193 nm. It seems that there is some free oxygen in the grain boundaries that does not allow the particles to grow up.

Figure 6 shows the FE-SEM images of the tantalum powder obtained after different reduction temperatures (at 950°C to 1100°C). The Ta powders were shaped in equiaxed form. It seems in reduction path, the starting Ta₂O₅

particles are fractured by oxygen in the first step, and then these particles are further reduced into Ta with Mg and oxygen reaction. The smaller sizes of reduced Ta nanoparticles are unstable and start joining with each other. However, the bigger size nanoparticles retain their equiaxed shapes [14, 20]. According to the XRD patterns and presence of oxygen in the Ta powders (Table 1), the oxygen has been consumed at reduction temperatures of above 1000°C and iron oxides have been produced. The particles were found fully agglomerated (950°C to 1200°C) and by increasing the temperature,

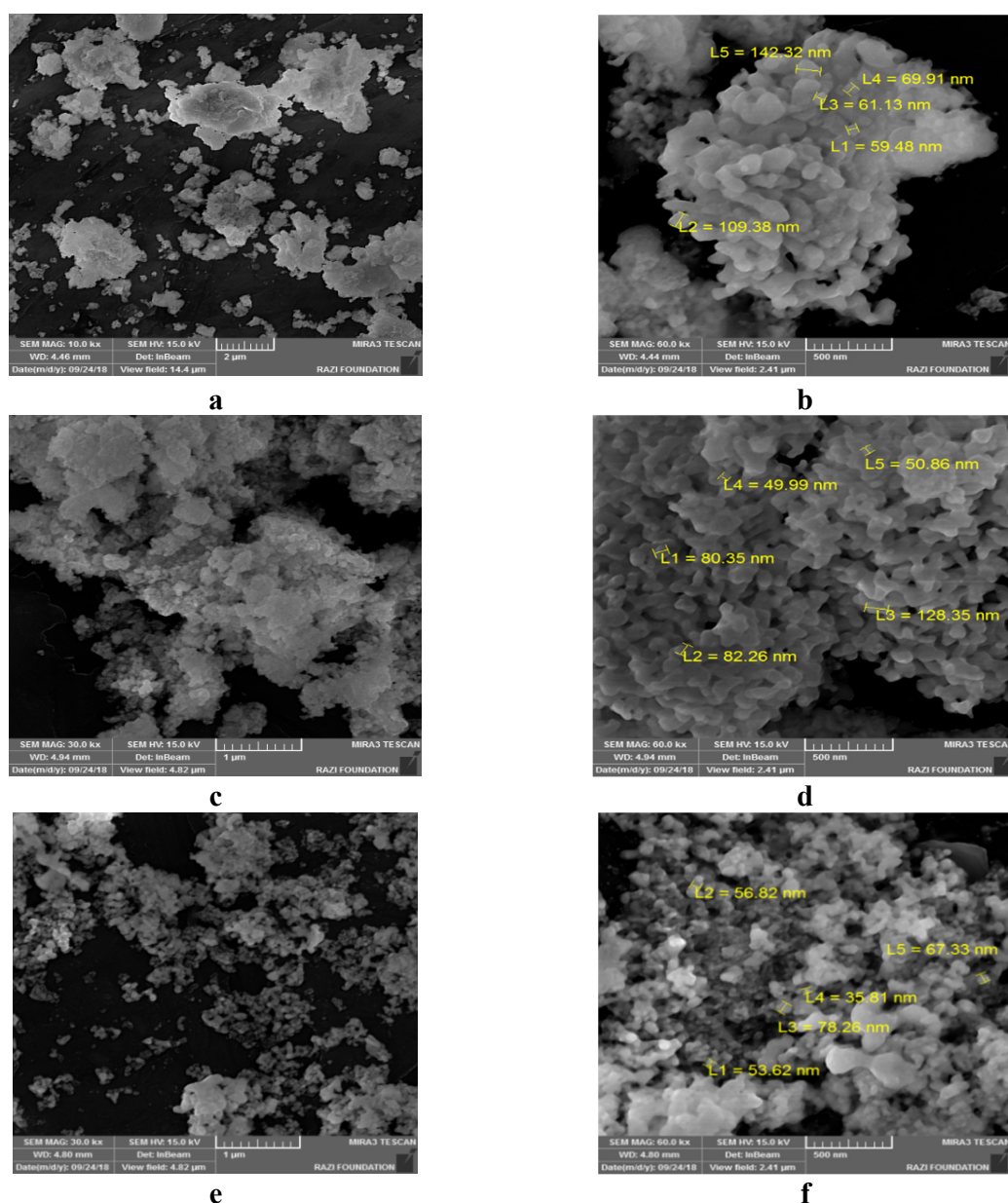

Fig. 6. The SEM morphology and particle size for produced Ta powders at different temperatures: (a & b) 1000°C, (c & d) 1100°C, (e & f) 950°C, double refined.

the agglomerated Ta particles tend to sprinkle from each other. The morphology of Ta powder produced at 1000°C (Figure 6-a&b) is more agglomerated but the particle sizes are more or less the same (Nanometer range) as compared with Figure 6-c&d(1100°C). The same phenomenon is observed for the powders synthesized at 1200°C. The nanometer particles (50-142 nm) tend to grow slowly in the temperature range of 1000°C to 1200°C, but this is not systematic.

The morphology of double refined no agglomerated Ta powders are shown in Figure 6-e&f. The double refined Ta powders synthesized at 950°C have equiaxed morphology with an average size of 58 nm. This morphological change is maybe due to absence impurities such as iron oxides and oxygen. It seems the have prevented the agglomeration of Ta powders. It is showing that any impurities such as iron oxides or oxygen content are responsible for agglomeration and size of Ta powders (Figure 6-a-d). The exact amount of impurities integrated by EDS results is shown in Table 3. The results are very much compatible with MAUD data (Table 1) in XRD examination.

Table 3. The calculated percentage of elements (wt %) integrated by EDS results at various temperature

Reduction		Tantalum	Iron	Oxygen
Time (hr.)	Tem. (°C)			
3	1200 (single)	74.9	18.54	6.56
3	1100 (single)	85	10.74	4.26
3	1000 (single)	95.68	3.09	1.23
3	950 (single)	98.62	0.98	0.4
4	950 (double)	100	0	0

4. CONCLUSIONS

The process of producing Ta powder from Ta scrap was pursued in this study using Mg and Ca as reducing agents. The reduction temperature to form Ta powders with Mg reagent (34 nm average particles) was optimized at 950°C for 180 minutes. The efficiency of double reduced Ta

powder with calcium reagent is obtained to about 97% at 950°C. The oxygen contents in Ta powder were reduced to 250 ppm with an average size of 58 nm, when the Ta powder was subjected to double refinement.

5. REFERENCES

- [1] Rowe, C. E. D. The use of tantalum in the process industry. *Journal of Minerals, Metals and Materials Society*, 1997, 49(1), 26-28.
- [2] Brar, L. K., Singla, G., Kaur, N., & Pandey, O. P. Thermal stability and structural properties of Ta nanopowder synthesized via simultaneous reduction of Ta₂O₅ by hydrogen and carbon. *Journal of Thermal Analysis and Calorimetry*, 2015, 119(1), 175-182.
- [3] Yoo, S. H., Sudarshan, T. S., Sethuram, K., Subhash, G., & Dowding, R. J. Consolidation and high strain rate mechanical behavior of nanocrystalline tantalum powder. *Nanostructured Materials*, 1999, 12(1-4), 23-28.
- [4] Khaleghi, E., Lin, Y. S., Meyers, M. A., & Olevsky, E. A. Spark plasma sintering of tantalum carbide. *Scripta Materialia*, 2010, 63(6), 577-580.
- [5] Park, K. Y., Kim, H. J., & Suh, Y. J. Preparation of tantalum nanopowders through hydrogen reduction of TaCl₅ vapor. *Powder technology*, 2007, 172(3), 144-148.
- [6] Kolosov, V. N., Miroshnichenko, M. N., Orlov, V. M., & Prokhorova, T. Y. Potassium-reduced tantalum powders. *Russian journal of applied chemistry*, 2005, 78(4), 538-540.
- [7] Kolosov, V. N., Orlov, V. M., Miroshnichenko, M. N., & Prokhorova, T. Y. Preparation of high-purity tantalum powders by sodium-thermal reduction. *Inorganic Materials*, 2012, 48(9), 903-907.
- [8] Kim, B. S., & Choi, Y. Y. Kinetics of the chlorination reaction of tantalum pentoxide with carbon tetrachloride gas. *Materials transactions*, 2005, 46(9), 2102-2106.
- [9] Shainyan, B. A., Danilevich, Y. S., Garmazov, Y. L., Finkelstein, A. L., Aisueva, T. S., & Turchaninov, V. K. Novel technology for chlorination of

- niobium and tantalum oxides and their low-grade ore concentrates. *Journal of Minerals and Materials Characterization and Engineering*, 2008, 7(02), 163.
- [10] Elanski, D., Mimura, K., Ito, T., & Isshiki, M. Purification of tantalum by means of hydrogen plasma arc melting. *Materials Letters*, 1997, 30(1), 1-5.
- [11] Yuan, B., & Okabe, T. H. Production of fine tantalum powder by preform reduction process using Mg–Ag alloy reductant. *Journal of alloys and compounds*, 2007, 443(1-2), 71-80.
- [12] Mineta, K., & Okabe, T. H. Development of a recycling process for tantalum from capacitor scraps. *Journal of Physics and Chemistry of Solids*, 2005, 66(2-4), 318-321.
- [13] Matsuoka, R., Mineta, K., & Okabe, T. H. Recycling Process for Tantalum and Some Other Metal Scraps. In *EPD Congress*, 2004.
- [14] Baba, M., Ono, Y., & Suzuki, R. O. Tantalum and niobium powder preparation from their oxides by calciothermic reduction in the molten CaCl_2 . *Journal of Physics and Chemistry of Solids*, 2005, 66(2-4), 466-470.
- [15] Efe, M., Kim, H. J., Chandrasekar, S., & Trumble, K. P. The chemical state and control of oxygen in powder metallurgy tantalum. *Materials Science and Engineering: A*, 2012, 544, 1-9.
- [16] Garg, S., Krishnamurthy, N., Awasthi, A., & Venkatraman, M. The O-Ta (oxygen-tantalum) system. *Journal of Phase Equilibria and Diffusion*, 1997, 4(18), 407-408.
- [17] Stecura, S. Observation of oxide particles below the apparent oxygen solubility limit in tantalum. *Metallurgical Transactions*, 1974, 5(6), 1337-1340.
- [18] Okabe, T. H., Sato, N., Mitsuda, Y., & Ono, S. Production of tantalum powder by magnesiothermic reduction of feed preform. *Materials transactions*, 2003, 44(12), 2646-2653.
- [19] Massalski, T. B. Binary alloy phase diagrams. *ASM international*, 1992, 3, 2874.
- [20] Hwang, S. M., Wang, J. P., & Lee, D. W. Extraction of Tantalum powder via the magnesium reduction of tantalum pentoxide. *Metals*, 2019, 9(2), 205.
- [21] Gerstenberg, D., & Calbick, C. J. Effects of nitrogen, methane, and oxygen on structure and electrical properties of thin tantalum films. *Journal of Applied physics*, 1964, 35(2), 402-407.
- [22] Suzuki, R. O., Baba, M., Ono, Y., & Yamamoto, K. Formation of broccoli-like morphology of tantalum powder. *Journal of alloys and compounds*, 2005, 389(1-2), 310-316.