

MAGNESIUM PRODUCTION FROM ASIAN ABE-GARM DOLOMITE IN PIDGEON-TYPE REACTOR

B. Mehrabi¹, M. Abdellatif² and F. Masoudi³

* *f_masoudi@sbu.ac.ir*

Received: December 2010

Accepted: April 2011

¹ Geology Department, Tehran Tarbiat Moallem University, Tehran, Iran

² Mintek Co., Randburg, 2125, South Africa

³ Faculty of Earth Sciences, Shahid Beheshti University, Tehran, Iran

Abstract: Ore mineral characterization and various experimental testwork were carried out on Asian Abe-Garm dolomite, Qazvin province, Iran. The testwork consisted of calcining, chemical characterization, LOI determination, and reduction tests on the calcined dolomite (doloma), using Semnan ferrosilicon. Calcining of dolomite sample was carried out at about 1400 °C in order to remove the contained CO₂, moisture, and other easily volatilised impurities. The doloma was milled, thoroughly mixed with 21% Semnan ferrosilicon and briquetted in hand press applying 30 MPa pressure. The briquettes were heated at 1125-1150 °C and 500Pa in a Pidgeon-type tube reactor for 10-12 hours to extract the magnesium. Ferrosilicon addition, relative to doloma, was determined based on the chemical analyses of the two reactants using Mintek's Pyrosim software package. Magnesium extraction calculated as 77.97% and Mg purity of 96.35%. The level of major impurities in the produced magnesium crown is similar to those in the crude metal production.

Keywords: Mg metal, Pidgeon process, Asian Abe-Garm dolomite, Semnan ferrosilicon, Calcining, Silicothermic reduction.

1. INTRODUCTION:

In the Pidgeon Process, magnesium metal is extracted from calcined dolomite under vacuum and at high temperatures using ferrosilicon as a reducing agent [1]. In this process, the finely crushed dolomite is feed into kilns where it is calcined. The calcined dolomite is then pulverized in a mill prior to mixing with finely ground ferrosilicon. After weighing and homogenizing the fine calcined dolomite and ferrosilicon, the mixture is briquetted. Briquettes are charged in a retort and put in the reduction furnace. The reduction operation is a batch process releasing magnesium in vapor form, which condenses in the cooled end of the retort outside furnace wall. After removal from the furnace, the magnesium "crown" is taken off the sleeves [1].

Approximately, 80% of the world demand for magnesium is currently supplied by China and nearly 95% of the primary magnesium output of China is produced using the Pidgeon process mainly due to low labor and energy costs and lax environmental act [2, 3, 4]. The main scope of this research is to characterize Asian Abe-Garm dolomite ore and its technical evaluation for magnesium metal extraction in the Pidgeon-type

reactor.

In spite of enormous dolomite resources, two ferrosilicon manufacturers and relatively cheap energy, magnesium is not being produced in Iran. The Iranian market conditions are mainly in favor of the Pidgeon process, over the electrolytic [5]. Extensive review, fieldwork, sampling and mineralogical and chemical analyses of major dolomite resources in Iran [5] demonstrate that Asian Abe-Garm dolomite is one of the most suitable dolomite ore in Iran. It is located in area with the suitable industrial infrastructures (Qazvin Province) for future development of an Mg plant [5, 6].

In the present study, Asian Abe-Garm mine dolomite ore was characterize using optical mineralogy in Tehran Tarbiat Moallem University, XRF and XRD analysis in Iranian mineral processing research center (IMPRC). The calcining and the thermal reduction testworks using Semnan ferrosilicon were carried out in Mintek Laboratories in South Africa.

2. EXPERIMENTAL PROCEDURE

Asian Abe-Garm dolomite mine is located in 85 km southwest of the Qazvin city, Qazvin

Province (Fig. 1). Its estimated reserve is 1.7 Mt with annual production of 10 kt/y from the Jurassic Lar formation dolomite. In current research, samples were collected from Asian Abe-Garm mine during two session of fieldwork. Petrography of 60 samples were carried out using Zeiss Axioplan2 polarized light microscope after alizarin red and potassium ferricyanide staining [7] for recognition of dolomite and calcite (Fig. 2). Selected samples were analyzed by Philips Magic-Pro XRF (Table 1) and Philips Expert-Pro XRD (Table 2) in IMPRC. Dolomite ore is thin bedded, beige colored, and exhibit non-planar, planar S and planar E textures [8] with crystal size in range of 0.03 to 0.5 mm. The major impurities are calcite veinlets and fine-grained quartz crystals (>0.1 mm).

Lloyd M. Pidgeon in Canada pioneered the silicothermic reduction of calcined dolomite to metallic magnesium using the abundantly available dolomite mineral during World War II [9]. In the Pidgeon process, magnesium metal is produced from calcined dolomite under vacuum and at high temperatures using ferrosilicon as a reducing agent [10]. The Pidgeon process is currently the most widely used process for the production of magnesium. This batch process

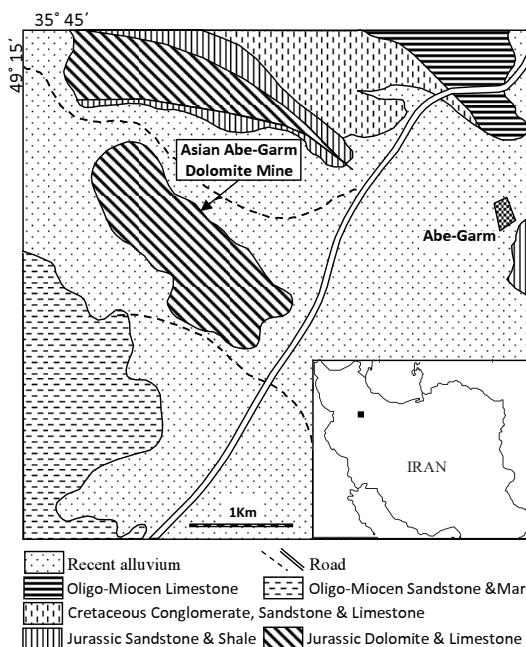

Fig. 1. Simplified geological map of Asian Abe-Garm dolomite deposit.

involves reduction of doloma by ferrosilicon, carried out at temperature between 1100-1200 °C under vacuum in a retort, producing magnesium vapour which is then cooled and collected as a

Table 1. Chemical composition of Asian Abe-Garm dolomite samples (as %, Rb and Sr in ppm).

	AA50	AA 51	AA 52	AA 53	AA 54	AA 55	AA 56	AA 57
TiO ₂	0.05	0.05	0.02	0.05	0.05	0.05	0.05	0.04
Al ₂ O ₃	n.d	n.d	n.d	n.d	n.d	n.d	n.d	n.d
Fe ₂ O ₃	n.d	0.17	0.01	0.12	0.11	0.05	0.07	0.12
CaO	33.37	30.63	33.40	27.70	40.64	33.32	32.25	31.60
MgO	19.87	19.00	20.37	15.32	13.30	20.29	20.56	20.49
Na ₂ O	n.d	n.d	n.d	n.d	n.d	0.25	n.d	n.d
K ₂ O	n.d	n.d	0.01	n.d	n.d	0.02	n.d	n.d
MnO	0.01	0.04	0.01	0.02	0.02	0.02	0.02	0.02
P ₂ O ₅	0.02	0.01	0.02	0.01	0.01	n.d	0.02	0.01
S	n.d	n.d	n.d	n.d	n.d	n.d	n.d	n.d
Rb	n.d	6	2	n.d	n.d	n.d	3	5
Sr	89	109	88	125	137	98	78	66
SiO ₂	0.11	6.09	0.65	11.89	0.00	0.00	0.33	0.86
L.O.I	46.60	44.00	45.50	44.90	45.90	46.00	46.70	46.90

Table 2. XRD quantitative analyses data.

Sample No.	AA10	AA13	AA15	AA17	AA50	AA53	AA54	AA57
Mineral								
Dolomite	97.3	74.7	97.1	96.5	98.2	85.0	83.6	98.7
Calcite	2.5	24.9	2.6	3.5	1.8	5.0	15.4	1.3
Quartz	0.2	0.4	0.3	-	-	10.0	-	-

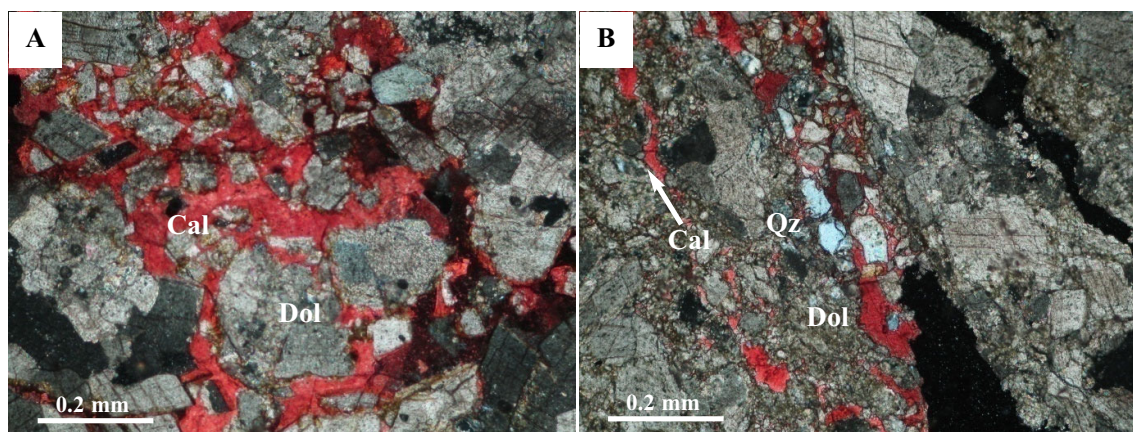
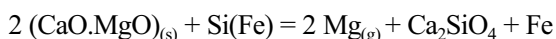
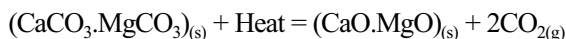

Fig 2. Photomicrograph of Asian Abe-Garm dolomite samples after staining, showing calcite fracture filling texture and quartz grain. A) Coarse grain dolomite and calcite as fracture filling. B) Medium to coarse grain dolomite, patchy calcite and quartz grain. (Cal=Calcite, Dol=Dolomite, Qz=Quartz)

condensate. The reactions of the Pidgeon process are:



The calcined dolomite and ferrosilicon are mixed and briquetted to improve the rates of heat transfer and the solid-state reaction. The major attractions of the process are its simplicity and low capital cost; however, the process is also labor and energy intensive [10].

The experimental testworks were carried out in the Mintek Laboratories in South Africa. The calcining of a representative dolomite sample from the Asian Abe-Garm mine was carried out in an induction furnace consisted of steel housing, alumina insulating bricks, and copper induction coils for four hours at 1400 °C in order to drive off almost all of the carbon dioxide and moisture, as well as the easily volatilized components. A K-type thermocouple was used to measure the sample temperature and was

positioned just above the magnesia crucible that contained the sample. After cooling, the mass loss was measured and sample was taken and analyzed (Table 3).

Based on industrial practice [11] Mintek's Pyrosym software [12] and experimental data FeSi addition was set as 21%. The Semnan ferrosilicon and Asian Abe-Garm doloma were

Table 3. Chemical analyses of Asian Abe-Garm dolomite, doloma and Semnan ferrosilicon.

Component	Dolomite,	Doloma	Ferrosilicon	
	mass %	mass%	Component	mass %
MgO	20.90	38.37	Mg	0.03
CaO	31.60	59.71	Ca (ppm)	<20
Al ₂ O ₃	0.01	0.17	Al	1.26
SiO ₂	0.44	0.91	Si	72.10
Fe ₂ O ₃	0.12	0.30	Fe	19.11
MnO	0.04	0.03	Mn	0.11
Ni	<0.05	<0.05	Ni (ppm)	65
LOI	47.60	<0.05	C	0.08

accurately weighed (about 200 g in total), mixed, and pulverized down to $-150\ \mu\text{m}$ in a ball mill. The mixture was then pressed to produce briquettes of 30mm in diameter and 15mm thick using a hydraulic press applying 30MPa pressure. The final mass of the briquettes was then recorded prior to being placed inside the retort.

Reduction tests performed on the briquetted mixture using the retort set-up shown in Fig. 3. The set up consisted of a 316 stainless steel tube (100 mm ID and 480 mm long). The tube (retort) was housed inside an electrically heated furnace (silicon carbide elements). The furnace insulated with alumina bricks, provided with a programmable temperature controller.

The retort contained a gas outlet, which was connected to a vacuum system. This system consisted of a vacuum pump, pressure transducer, pressure and temperature readouts, a shut-off valve, and argon purge line. Two thermocouples were used to measure and control the temperature. The first was placed just outside the retort, while the second was located inside it to measure and record the reaction temperature. The pressure and temperature readings were recorded throughout the test using a data logger.

After sealing, the retort was pressure-tested by applying vacuum of 500-700 Pa, switching off the vacuum pump, and monitoring the pressure readings. A leakage rate of $0.5\ \text{cm}^3/\text{min}$, or less, was considered to be acceptable to commence with the reduction test. Once the leak test is

successful, the retort was heated up to $700\ ^\circ\text{C}$ over a two-hour period. This was followed by a degassing period of two hours (at $700\ ^\circ\text{C}$) in order to drive off any residual moisture and/or carbon dioxide that could have been present in the reactants. For a short period of time, the retort pressure would increase slowly by 100-300 Pa during this period, before dropping down to 500-600 Pa. The temperature was then increased to $1150\ ^\circ\text{C}$ over a two-hour period. The reduction reaction was allowed to continue for about 8 hours. The pressure tended to increase slightly when the temperature approached $1100\text{-}1150\ ^\circ\text{C}$. This pressure change was similar to that observed during the degassing period and lasted for only a few minutes. The furnace was switched off (as well the vacuum pump), and the system pressure was brought up to just above atmospheric by flowing argon into the retort. Finally, the facility was allowed to cool down to near room temperature before opening the retort and collecting the products.

Both the slag and magnesium crown masses were measured and recorded, and representative samples were taken for chemical analysis. In the commissioning and actual test, a small amount of powder formed on the side-walls of the retort (less than 1 gram), particularly near the flange area. This material was recovered, weighed, sampled and analyzed separately. Beside actual test, commissioning test was carried out.

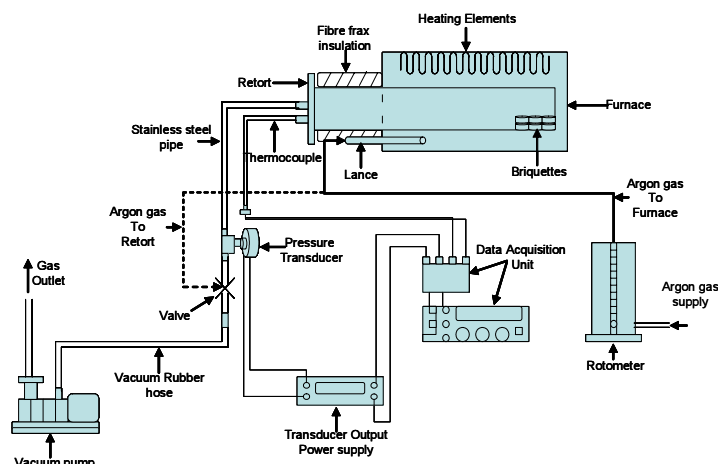

Fig. 3. The set up used for experimental work in Mintek Lab. South Africa.

3. RESULT AND DISCUSSIONS

The chemical composition of Asian Abe-Garm dolomite, doloma and Semnan ferrosilicon is presented in Table 3. The Semnan plant ferrosilicon ranked as Fe-75 wt% Si while it reanalysed in Mintek showed about 72% silicon and 19 % iron. The products of silicothermic reduction test consisted of three distinct phases; crown magnesium, a white deposit that tended to stick to the side-walls of the retort (less than a gram), and the reacted briquettes (slag). Each product was carefully removed from the retort, weighed, sampled, and sent to Lab. for analysis.

In Table 4 both iron and silicon are expressed as oxides. This is not entirely true, as most of the iron and un-reacted silicon tend to form a FeSi alloy (residual ferrosilicon). Other metals (Mn, Ni, etc) tend to concentrate in the FeSi product.

Chemical analysis of crown magnesium suggests that impurity levels are not significantly different from those contained in crude magnesium produced in the Magnetherm or Mintek Thermal magnesium processes [13, 14].

The magnesium extraction calculated based on two methods (Table 5). The first is based on the mass difference between the feed, the slag and the magnesium content of the crown. The second

approach takes into account the slag mass and its magnesium content. As such, the later results in lower magnesium extraction, compared to the first method. Magnesium extraction calculated based on the mass of briquette residue (slag) and its magnesium content is more reliable. Magnesium extraction defined as:

$$(Magnesium\ in\ feed - Magnesium\ in\ briquette\ residue) / Magnesium\ in\ feed (100\%),$$

where:

$$Magnesium\ in\ feed = Doloma\ mass * Mg\ analysis\ in\ doloma$$

$$Magnesium\ in\ briquette\ residue = Briquette\ residue\ mass * Mg\ analysis\ in\ Briquette\ residue\ mass$$

The last column in Table 5 is a preliminary estimate of the magnesium condensation efficiency indicates that the calculated value is very high for the test. Magnesium condensation defined as:

Table 4. Chemical analyses of the slag and Mg crown (mass %).

Slag	Mass%	Mg Crown	Mass%
MgO	8.46	Mg	96.35
CaO	59.36	Al	<0.05
Al ₂ O ₃	0.96	Si	0.05
SiO ₂	35.14	Ca	2.61
FeO	5.81	Mn	0.06
MnO	<0.06	Ni	<0.05
Ni	<0.05	Fe	0.06

Table 5. Magnesium extraction from Asian Abe-Garm dolomite.

Extraction, %		Condensation Efficiency, %
Mass Loss	Slag Analysis	
86.34	77.94	100

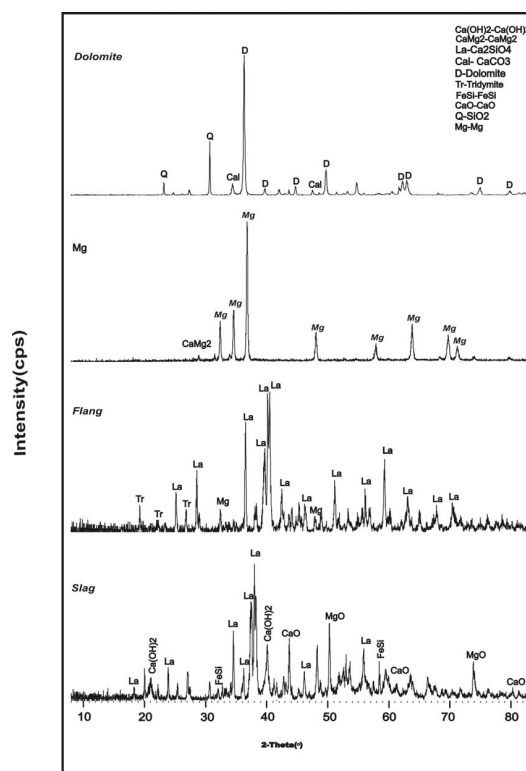

Fig. 4. XRD pattern of Asian Abe-Garm dolomite, Mg crown, white precipitated inside flange and slag.

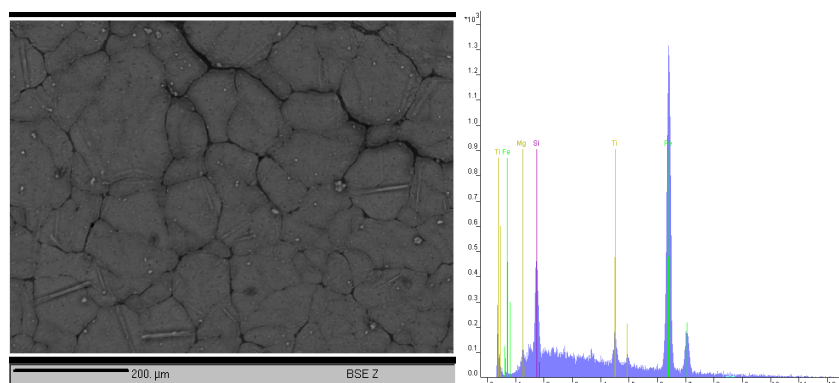

Fig. 5. BSE/EPMA image of crown Mg and chemical composition of the white area (EDAX). The Fe and Si are the main impurities as a residual ferrosilicon.

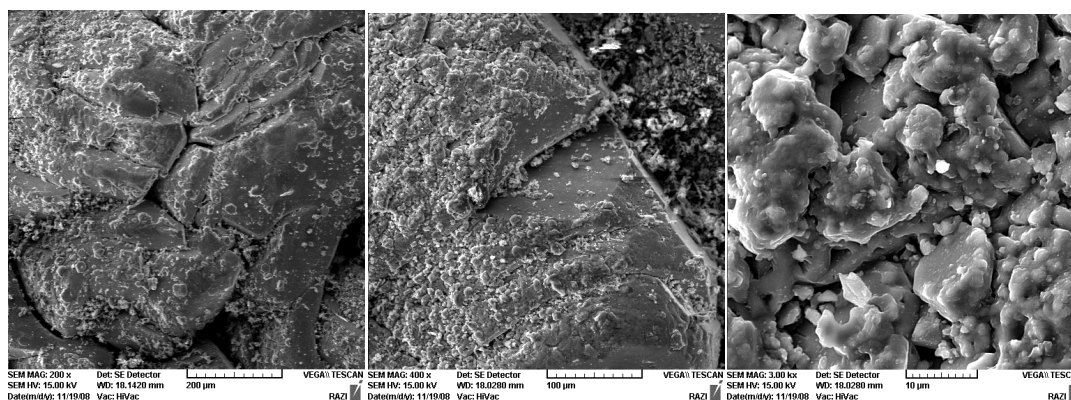

Fig. 6. BSE/SEM image of crown magnesium crystals. A & B) Show the crystalline magnesium covered with the late stage low crystalline magnesium. C) Late stage low crystalline magnesium deposited on the high crystalline magnesium.

$$Mg \text{ condensation} = \frac{\text{Magnesium in the crown}}{\text{Magnesium extracted}} * 100\%$$

The crown magnesium, slag and white deposit in side of the retort subjected to XRD (Figure 4). The crown magnesium was also examined using Cameca SX-100 EPMA (Figure 5) and TESCAN SEM (Figure 6). The area covered by crystalline magnesium is pure while in low crystalline area which seems formed in the late stage (Figure 6-C) of condensation there are traces of calcium, silica and iron (Figure 5). The main impurity in the crown magnesium is ferrosilicon (Figure 5).

4. CONCLUSION

Chemical and mineralogical analysis of the Asian Abe-Garm dolomite sample indicates that

it is suitable for magnesium production in a Pidgeon process. Testworks on Asian Abe-Garm calcined dolomite and its reduction by Semnan ferrosilicon in classic Pidgeon-type retort yield a suitable magnesium metal in terms of magnesium extraction and crude magnesium metal quality. Magnesium extraction from Asian Abe-Garm calcined dolomite is within the expected range. Magnesium extraction is 77.97% and magnesium grade is 96.35% in the experiment. In spite of low Si content of Semnan ferrosilicon (72%) compared with the industry standard (75%) and no addition of fluorite as a catalyst to the mixture, magnesium extraction was acceptable, indicating the suitability of Asian Abe-Garm dolomite for Mg metal production. The level of major impurities in the magnesium crown is similar to those in the crude metal production.

ACKNOWLEDGMENT

Authors would like to thank the Iranian Ministry of Industries and Mines for financial support.

REFERENCES

1. Habashi, F., Handbook of Extractive Metallurgy, 1997, Vol. 2; Wiley.
2. Cherubini, F., Raugei, M. and Ulgiati, S., "LCA of magnesium production; technological overview and worldwide estimation of environmental burdens". Resources, Conservation and Recycling, 2008, 52, 1093-1100.
3. Ding, W. and Zang, J., "The Pidgeon process in China", Proceedings of 3rd Annual Australasian Magnesium Conference, Sydney, Australia, 2001, 7.
4. Zang, J. and Ding, W., "The Pidgeon process in China and its future" Magnesium Technology 2001, Proceedings of the Mineral, Metals and Material Society Annual Meeting, New Orleans, Louisiana, 2001, 7-10.
5. Mehrabi, B., "The most suitable technology for magnesium production from Mg-bearing minerals in Iran". University of Industries and Mines, Makta1324-MIM grant, Final Report, 2005 (In Persian).
6. Mehrabi, B. and Masoudi, F., "Magnesium metal production using Lloyd Pidgeon process". University of Industries and Mines, Makta 17238-MIM grant, Final Report, 2009 (In Persian)
7. Dickson, J. A. D., "A modified technique for carbonates in thin section". Nature, 1965, 205, 587.
8. Sibley, D.F., Gregg, J.M., "Classification of dolomite rock textures". Journal of Sedimentary Petrology, 1987, 57, 967-975.
9. Pidgeon, L. M. and Alexander, W. A., "Thermal production of magnesium-Pilot plant studies on the retort ferrosilicon process". Transactions AIME, 1944, 159, 315-352.
10. Wulandari, W., Rhamdhani, A., Brooks, G. & Monaghan, B. J., "Distribution of impurities in magnesium via silicothermic reduction" Proceedings of European Metallurgical Conference, Austria, 2009, 1401-1415.
11. Mayer A., "Plant production of magnesium by the ferrosilicon process". Proceedings of AIMM, New York Meeting: reduction and refining of non-ferrous metals. Trans Am. Inst. Mining Mater. Eng., 1944; 363-376.
12. Jones, R. T., "Computer Simulation of Pyrometallurgical Processes"; Proceedings of the Twentieth International Symposium on the Application of Mathematics and Computers in the Minerals Industries, 1987, V2, 265.
13. Abdellatif, M., "Pilot plant demonstration of the Mintek Thermal Magnesium Process" Proceedings of the International Symposium on Magnesium Technology in the Global Age, Quebec, Canada, 2006, 67-80.
14. Abdellatif, M., "Refining testwork on crude magnesium produced in the Mintek Thermal Magnesium Process", Proceedings of Southern African Pyrometallurgy International Conference, Johannesburg, South Africa, 2006, 343-355.