



Approaching Influence of Vehicle's Properties in Crosswind and Overtaking Situations Using Multi-Step Taguchi Method

Sina Sadeghi¹, Majid Moavenian^{*},

¹ MSc student, Department of Mechanic, Faculty of Engineering, Ferdowsi University of Mashhad, Iran

^{*} Associate Professor, Department of Mechanic, Faculty of Engineering, Ferdowsi University of Mashhad, Iran

ARTICLE INFO

Article history:

Received : 22 June, 2019

Accepted: 5 Aug , 2019

Published: 1 Sept , 2019

Keywords:

Crosswind

Overtaking

Taguchi method

Lateral Deviation

Sensitivity

ABSTRACT

Most of drivers have to compensate small directional deviations from the desired driving path when disturbances such as crosswinds, overtakings, road irregularities and unintended driver inputs are imposed. These types of deviations have a tiring effect on driver and traffic's safety and should be minimised. To increase the understanding the influence of vehicle's properties in crosswind and overtaking conditions, specially vans and buses, and improving their safety, the vehicle was modeled using parameters based on real vehicle data for simulation in CarSim program. These parameters were validated or edited by simulation programs such as SOLIDWORKS, ADAMS/CAR ADAMS/CHASSIS and Well-known Calculation Software . A method for estimating the lateral error of vehicle due to original path in crosswind and overtaking conditions is also presented using Multi-Step Taguchi method in MINITAB. Dealing with limited but most effective factors of Vehicle's Properties instead of large variety of them can be used for optimal vehicle's design and propose ideal Crosswind Controllers.

1. Introduction

The handling behavior in crosswinds of fast, vehicles like vans, buses and trucks becomes more and more important as a result of the development of streamlined vehicle bodies. Generally vehicles with low drag coefficient and large cross section area are more sensitive to crosswind [1].

Up to now, one of the experimental methods is testing crosswind sensibility by using a side-wind blower facilities and evaluating the path deviation for controlling fields [2]. But in these methods, unwanted parameters have normally large angle of approach, neglecting the driver's response there are some chassis, steering and suspension factors which can have effective influence in derivation from original path in crosswind gust. In many cases, attempts at streamlining passenger cars for minimizing drag have led to unfavorable increases in crosswind sensitivity. As noted in such

comprehensive studies such as Huoyue Xiang et al [3] and Takuji[4], neglecting roll and pitch movements tradeoff was developed by Kamm [5] out of which arose the well-known truncated rear-end design ("Kamm-back") which helped to offset much of the crosswind susceptibility introduced from streamlining. More recent observations, such as Volpe [6] or Huoyue Xiang et al [3], have contributed to improved understandings on the impalpable influences relating to A and C-pillar styling body designs and their importance in affecting crosswind sensitivity of passenger cars. Numerous formulations aimed at simplified identifications of the crosswind sensitivity of passenger cars have been offered in the technical literature. At the FISITA Congress, Watari et al [7] offered a crosswind sensitivity formulation based upon the steady-state and uniform lateral acceleration response of a vehicle to a constant aerodynamic side force. Chen [8], proposed a formula for predicting the crosswind sensitivity based upon the initial transient response of a

^{*}Corresponding Author

Email Address: moaven@um.ac.ir

DOI: 10.22068/ijae.9.3.3002

vehicle to a step input of crosswind and its subsequent steady-state turning response. Guangsheng Du et al [9] conducted a simulation-based study involving systematic parameter variations of a validated computer model by Sayers et al [10] that included detailed representations of the vehicle dynamics, aerodynamic properties, steering system characteristics, and driver steering behavior. Numerous full-scale test programs have also been conducted which attempted to identify and illustrate influences of chassis and aerodynamic properties on vehicle crosswind sensitivity. Klein and Acosta [11] reported on findings of a full-scale test program involving five distinctly different U.S. vehicles. Crosswind tests were conducted with a newly-developed crosswind fan facility [12]. Proppe and Xhang [13] conducted similar tests with a group of 15 drivers at vehicle speeds of 100 km/h. A European crosswind fan facility was utilized which provided aerodynamic slip angles up to 20 degrees at such test speeds. However, they did note that yaw rate and lateral acceleration appeared to be the most useful measurements as discriminators of different vehicle configurations during these tests. Lastly, Winkler et al [14], also reported on a sequence of crosswind driver-vehicle tests conducted under natural crosswind conditions along a North Sea coast motorway. Willumeit's study indicated that the passive (non-driver, fixed steering wheel) vehicle response to crosswinds does not "fully correlate with driver's impressions of side wind sensitivity."

As it can be concluded previous works by focusing on specific geometry factors of vehicles did not reach a comprehensive and useful crosswind controller. In this paper, a specific type of van is selected to find the most effective aerodynamic and other design parameters including suspension, chassis, tire and engine factors in crosswind and overtaking situations. CarSim simulation data for the proposed vehicle were verified or validate by SOLIDWORKS/Flow Simulation for aerodynamic properties, ADAMS/CAR, ADAMS CHASSIS and ADAMS/TIRE for other parameters. By applying a method to find a similarity percentage between the vehicle path and original path, the Taguchi method get used to find effective factors.

2. Approach

A good chassis design compensates poor crosswind behavior of the body. So there was a need to develop a model which describes the

active crosswind behavior Crosswind behavior of the car body is responsible for aerodynamic properties and handling behavior of chassis. According to [1] these two parts can be described as a linear regression formula.

Before applying Taguchi Method for our specific Vehicle (Van Sprinter 2500), their systems parameters must be validate or verify by data library or simulation methods with their own academic and credible software. Four main vehicle system and their validation methods mentioned in Figure 1.

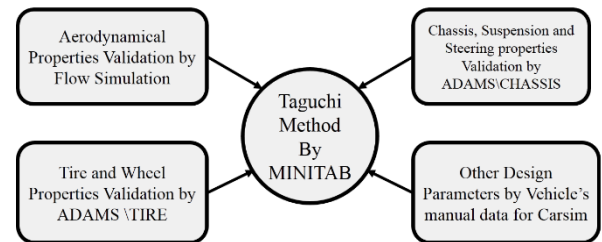

Figure1: Scheme of Four main classes of properties

2.1. Validation of Aerodynamic Properties

In this study a Benz Sprinter 2500 van is chosen for this research shown in Figure 2. In CarSim simulation software for this particular case after selecting the 'Europe Minivan' category, most of the data must be adjust, validate or insert due to data given from other mentioned simulation software or its manuals. As it is shown in Figure 3 aerodynamic parameters in red squares must be adjusted for this type of vehicle and rest of the parameters can be inserted directly based on manual script of the vehicle provided by Benz-Dailmer Company [15].



Figure2: Benz Sprinter 2500

Approaching Influence of Vehicle's Properties in Crosswind and Overtaking Situations Using Multi-Step Taguchi Method

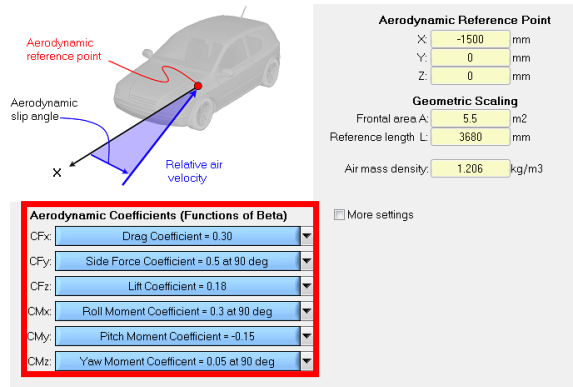

Figure3: CarSim Aerodynamic properties

To find the six aerodynamic parameters mentioned in red box of Figure 3, it is needed to model a 1:1 high accurate vehicle prototypical in SOLIDWORKS software as it is shown in Figure 4 and adding it to Flow Simulation tool and run its CFD study to obtain them. The CFD test applied under the test conditions given in Table 1.



Figure4: High accuracy SOLIDWORKS model of the vehicle

Table1: Flow Simulation Study Conditions

| Feature | Conditions |
|------------------|-----------------------|
| Analysis Type | Exclude |
| Initial Mesh | Auto (level 4) |
| Heat Conduction | Off |
| Time Dependency | Off |
| Flow Type | Laminar and Turbulent |
| Humidity | Off |
| Wall Conditions | Adiabatic |
| Thermodynamics | STP |
| Fluids | Air |
| Vehicle Velocity | 100km/h (X direction) |

By applying this proposed model with these CFD conditions, it takes more than days to get results by our laboratory computational services, so it can't be helped to simplify the vehicle's SOLIDWORKS model into clay model as it is

shown in Figure5. (all geometric parameters of the vehicle did not change)

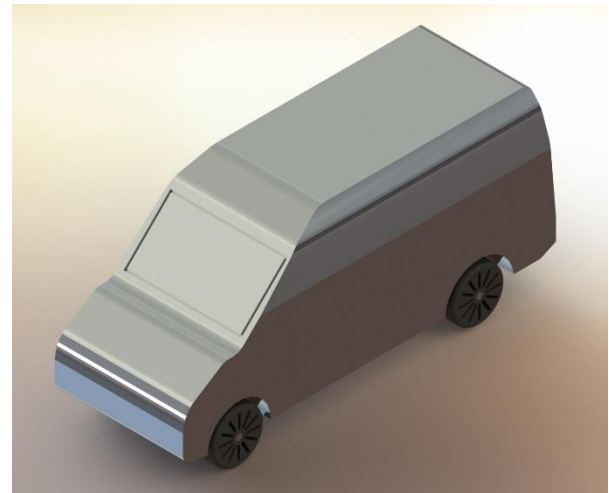

Figure5: Clay Model of the Vehicle in SOLIDWORKS

The results of running the flow simulation on aerodynamic coefficients and important flow trajectories are given in Table 2 and Figures 6 and 7.

Table2: Aerodynamic Coefficients Results

| Parameter | Notation | Value |
|--------------------------|----------|---------|
| Drag Coefficient | CF_x | 0.2893 |
| Side Force Coefficient | CF_y | 0.4981 |
| Lift Coefficient | CF_z | 0.2299 |
| Roll Moment Coefficient | CM_x | 0.3173 |
| Pitch Moment Coefficient | CM_y | -0.2136 |
| Yaw Moment Coefficient | CM_z | 0.1294 |

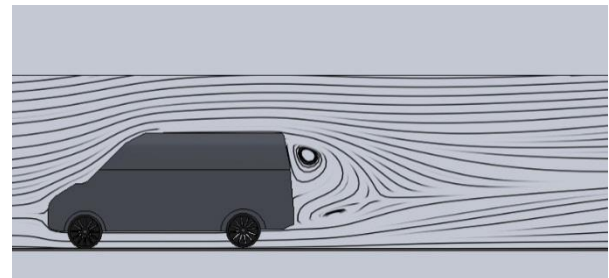

Figure6: Flow Trajectory of Air at speed of 100km/h

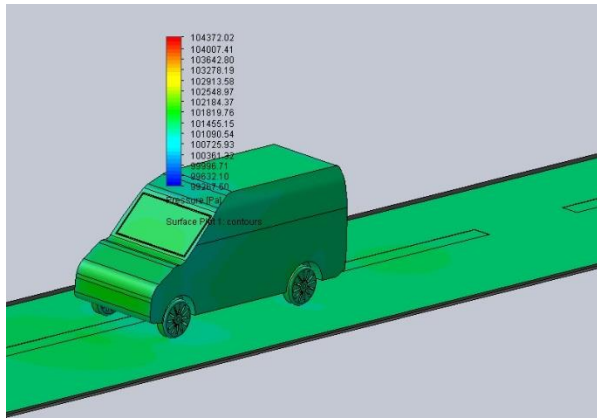

Figure7: Pressure Difference Plot around Vehicle of Air at speed of 100km/h

Figure 6 and 7 shows that the air vortex and pressure difference created at the end and sides of long vehicles (specially Buses and vans) during overtaking can have same effect as crosswind condition to deviate from original path (suction or repulsion after specific closure). To show the strong effect of air vortex caused by long vehicles overtaking, a separate Flow Simulation study for Bus-Van performed. The overtaking simulation progress is shown in Figures 8 and 9.

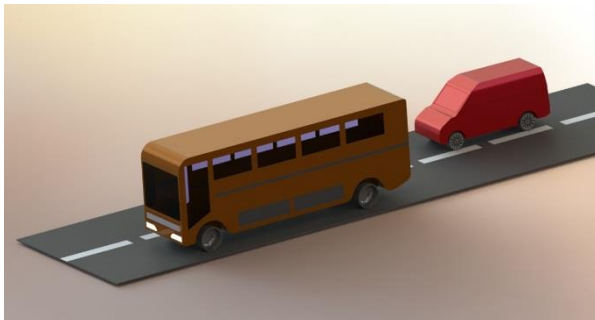

Figure8: Bus-Van overtaking SOLIDWORKS model for Flow Simulation Study before overtaking



Figure9: Bus-Van overtaking SOLIDWORKS model for Flow Simulation Study in overtaking

If ‘before overtaking’ named as Event 1 and ‘meanwhile the overtaking’ as Event 2 , by Flow Simulation Study the location of air vortex caused

by bus traveling is spotted and presented in the format of streamline contour in Figure 10 and Forces and Torques that applied to Van before and meanwhile the overtaking in Tables 3 and 4 and compare it in Figure 11. If any vehicles specially long ones reach this spot, suction or repulsion of the vortex will bring same effect as crosswind condition.[8]

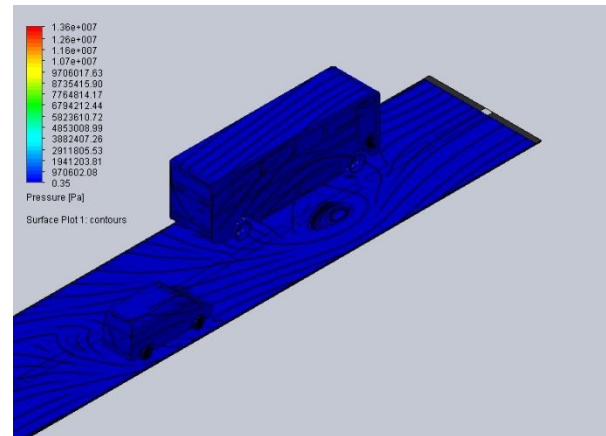

Figure10: Stream line Contour of Event 1 from above

Table3: Applied Forces and Torques in Event1

| Applied Force/Torque | Unit | Value |
|----------------------|------|-----------|
| F_x | N | 657.554 |
| F_y | N | 477.306 |
| F_z | N | 1007.199 |
| M_x | N.m | 8086.353 |
| M_y | N.m | 515.840 |
| M_z | N.m | -4292.749 |

The hotspot of side Air vortex of the bus occurs about 0.8m from its right side. Event 2 starts when the van reaches in this area. The effect of air vortex in deviating the van from original path, Forces and Torques applied to the van’s body measured.

Table4: Applied Forces and Torques in Event2

| Applied Force/Torque | Unit | Value |
|----------------------|------|-----------|
| F_x | N | 917.68 |
| F_y | N | 836.16 |
| F_z | N | 4161.42 |
| M_x | N.m | 65594.46 |
| M_y | N.m | -7184.87 |
| M_z | N.m | -13366.16 |

Approaching Influence of Vehicle's Properties in Crosswind and Overtaking Situations Using Multi-Step Taguchi Method

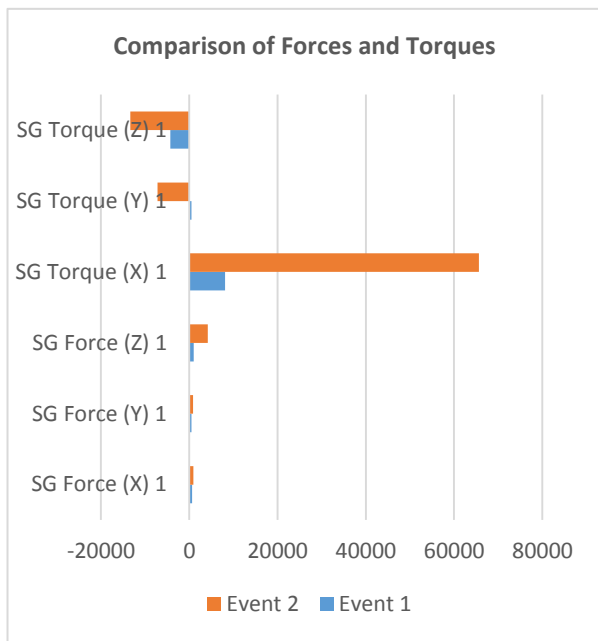

Figure 11: Comparison of Forces and Torques applied to Van's body

As its obvious it can be concluded that during the overtaking (specially two long vehicles) the amounts of force and torques grow 2 to 10 times greater than before overtaking and this can deviate the van easily. The only way to prevent this deviancy is using Crosswind Controller or handling the vehicle far enough the hotspot area. Figure 12 shows the amount of deviation in this process by CarSim program.

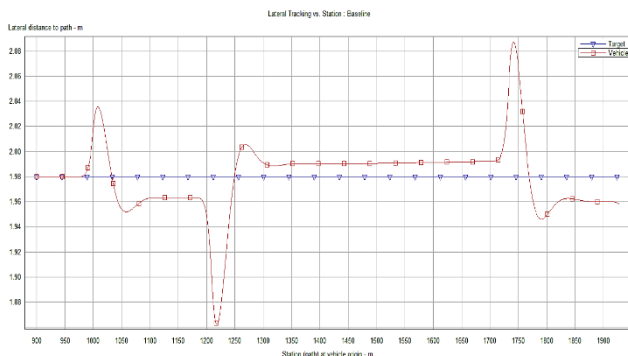

Figure 12 : Deviation Error due to original path in Bus-Van Overtaking

2.2. Validation of Tire and Wheels Parameters

CarSim Tire Section is Shown in Figure 13. Regarding to this page, it can be seen that parameters highlighted with colored boxes are needed to be verified. One of the most capable programs which has comprehensive data library is TDFT tool. This application is available by running "Component Analysis" of Adams Car software.

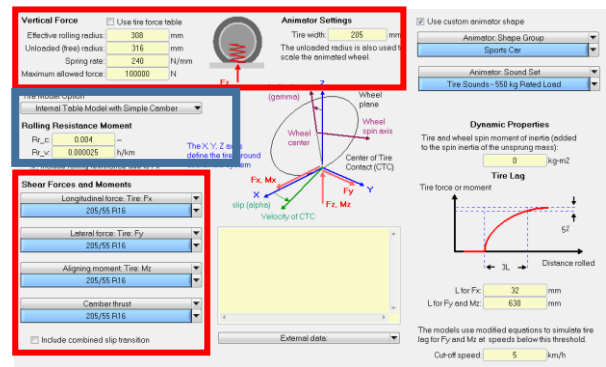

Figure 13: CarSim Tire parameters section

Due to Vehicle's company manual this van use 205/55R16 tire as default and can be used to verify data mentioned in first red box of Figure 13. But to gain other parameters it is needed to correct parameters like road condition, test speed and contact model after inserting from library. Figures 14-18 present branch pages of library which needed correction by red star beside them.

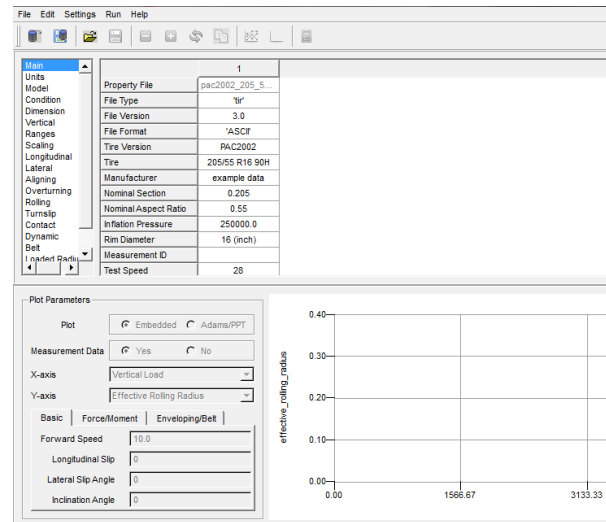

Figure 14: TDFT tool window and its branch pages

| 1 | |
|---------------|------------------|
| Property File | pac2002_205_5... |
| LENGTH | 'meter' |
| FORCE | 'newton' |
| ANGLE | 'radians' |
| MASS | 'kg' |
| TIME | 'second' |
| PRESSURE | 'pascal' |

Figure 15: Correction of setting MKGS unit

| | |
|----------------------|----------------|
| File Version | 1 |
| File Format | 3.0 |
| Tire Version | 'ASCII' |
| Tire | PAC2002 |
| Manufacturer | 205/55 R16 90H |
| Nominal Section | example data |
| Nominal Aspect Ratio | 0.205 |
| Inflation Pressure | 0.55 |
| Rim Diameter | 250000.0 |
| Measurement ID | 16 (inch) |
| Test Speed | ★ 28 |
| Road Surface | ★ Asphalt |
| Road Condition | ★ dry |

Figure16: Correction of test speed and road condition

| | |
|---------------|-------------------|
| Property File | 1 |
| FORMAT | pac2002_205_5... |
| USE_MODE | 0.0 |
| VXLOW | 24.0 |
| LONGVL | 0.06858 |
| TYRESIDE | 10.0 |
| BELT_DYNAMICS | ★ 'LEFT' |
| CONTACT_MODEL | ★ '3D_ENVELOPING' |

Figure17: Correction of contact model

| | |
|------------------|------------------|
| Property File | 1 |
| UNLOADED_RADIUS | pac2002_235_6... |
| WIDTH | 0.3169 |
| ASPECT_RATIO | 0.265 |
| RIM_RADIUS | 0.55 |
| RIM_WIDTH | 0.2032 |
| BOTTOMING_RADIUS | ★ 0.1651 |
| | 0.0 |

Figure18: Correction of condition page

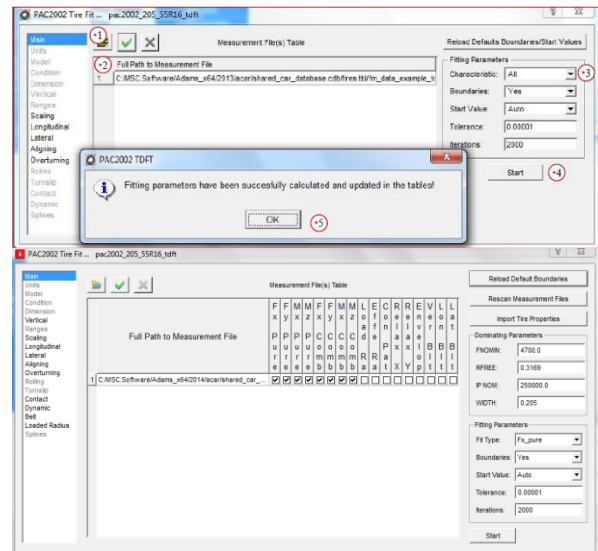

Figure19: Applying the 2D Flat Road in TDFT

After reviewing and completing the check list, for verifying the remnant data, specially the second red box of Figure 13, it is needed to run a “Symmetric Dynamic Load Transfer” test. The Process of running this test and applying a “2D_Flat_Asphalt_road” is shown in Figure 19. Results are given in Figures 20-26, and they must applied to CarSim tire section (Table data) as format of “2D Array Table” to update.

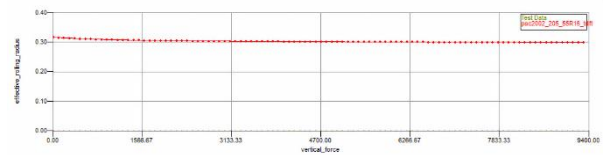

Figure20: Effective Rolling Radius

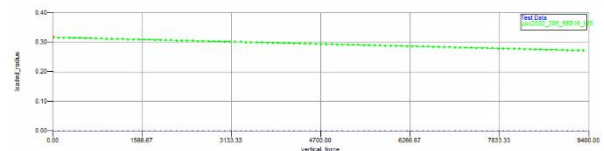

Figure21: Loaded Tire Radius

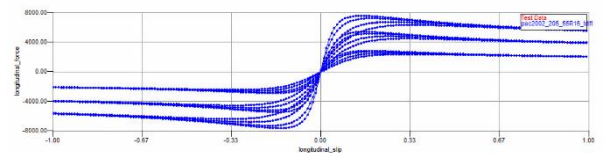

Figure22: Longitudinal Force Vs Longitudinal Slip

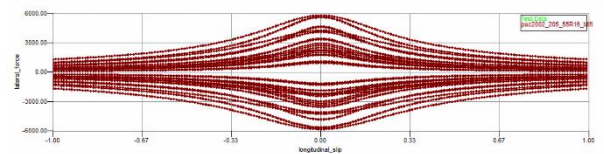

Figure23: Lateral Force Vs Longitudinal Slip

Approaching Influence of Vehicle's Properties in Crosswind and Overtaking Situations Using Multi-Step Taguchi Method

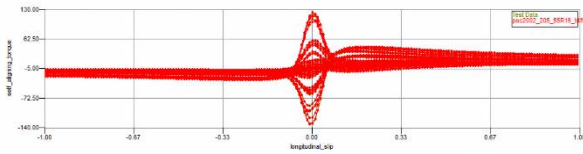

Figure 24: Self Aligning Torque Vs Longitudinal Slip

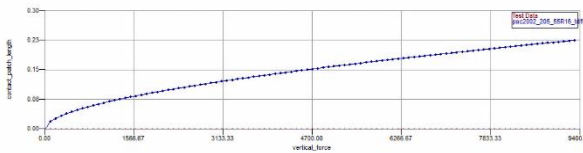

Figure 25: Contact Patch Length

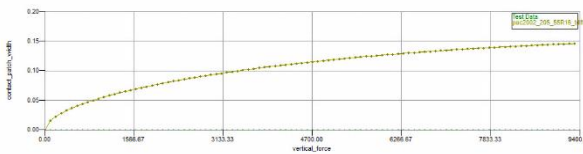

Figure 26: Contact Patch Width

Remaining data which not mentioned in results (e.g the blue box of Figure 17) are given over to own CarSim Library.

2.3. Validation of Steering and Suspension

Verification of steering and suspension's parameters is a big challenge. Tons of factors and not enough accessible data from vehicle's manufactures give us no choice other than using data library of softwares like "Adams Chassis" or calculator tools like "Circle Track Analyzer" and "Steering Geometry Simulation". Figures 27- 30 presents CarSim related pages of steering and suspension systems and their data which need validation by boxes.

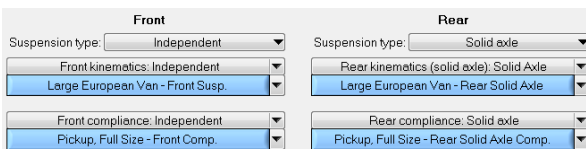

Figure 27: CarSim Suspension types of Vehicle

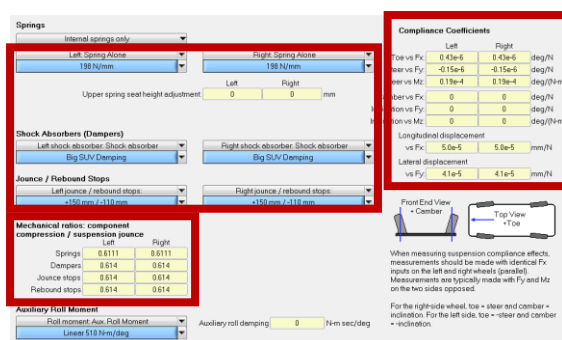

Figure 28: CarSim Front Suspension Section

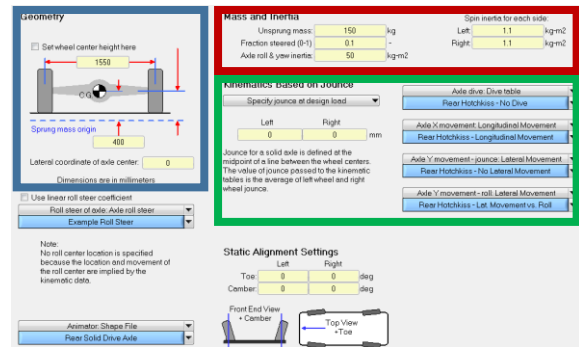

Figure 29: CarSim Rear Suspension Section

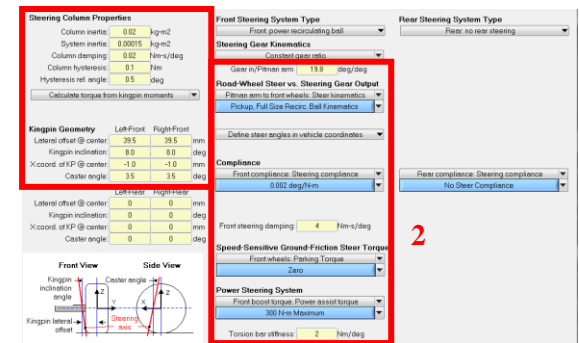

Figure 30: CarSim Steering System Section

The closet data base for our vehicle is "mini_van.vdb" and it can be used as reference for validation, but for further data it needs simulation test. The 3 steps route of inserting data base and running a test is pictured in Figure 31. However the chosen data library have the best similarity to our proposed vehicle but linearity or nonlinearity springs and dampers and bushing types for connectors must be corrected as much as they are available in company vehicle's manual shown in Figures 32-35 by red boxes. Bringing whole pages of this data base is out of scope of this paper, so we bring the ones which need mentioned corrections.

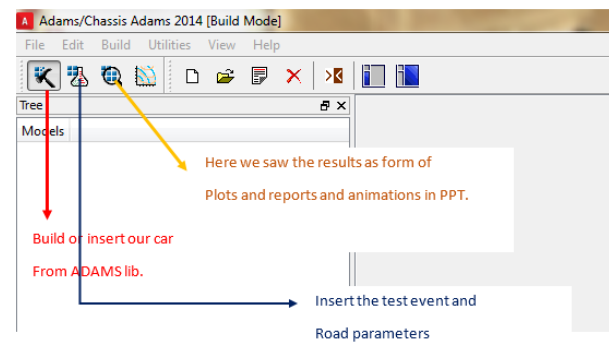

Figure 31: ADAMS/CHASSIS 3 steps route

| Name | Left Active | Left Type | Left Rate | Left No. Coils | Left Diameter | Right Active | Right Type | Right Rate | Right No. Coils | Right Diameter | Comment |
|-------------|-------------|-----------|-----------|----------------|---------------|--------------|------------|------------|-----------------|----------------|--------------------------------|
| coil_spring | yes | Linear | 87.5 | 5 | 107.0 | yes | Linear | 87.5 | 5 | 107.0 | Coil Springs |
| spring_2 | no | Linear | 77.1 | 5 | 120.0 | no | Linear | 77.1 | 5 | 120.0 | Spring - 2nd set (Coil Spring) |

Figure 32: Correction of spring data of “Adams Chassis” Library

| Name | Left Active | Left Type | Left Rate | Left Height | Left Diameter | Right Active | Right Type | Right Rate | Right Height | Right Diameter | Comment |
|------------------|-------------|------------|-----------|-------------|---------------|--------------|------------|------------|--------------|----------------|--------------------------|
| ounce_bumper | yes | Polynomial | 388.4 | 18.88 | 40.0 | yes | Polynomial | 388.4 | 18.88 | 40.0 | Ounce Bumpers |
| ounce_bumper_2 | no | Non-linear | Spline | 52.0 | 40.0 | no | Non-linear | Spline | 52.0 | 40.0 | ounce bumper - 2nd set |
| rebound_bumper | yes | Polynomial | 150.0 | 4.0 | 40.0 | yes | Polynomial | 150.0 | 4.0 | 40.0 | Rebound Bumpers |
| rebound_bumper_2 | no | Polynomial | 400.0 | 14.3 | 40.0 | no | Polynomial | 400.0 | 14.3 | 40.0 | rebound bumper - 2nd set |

Figure33: Correction of bumpers data of “Adams Chassis” Library

| Name | Left Active | Left Type | Left Rate | Right Active | Right Type | Right Rate | Comment |
|----------|-------------|------------|-----------|--------------|------------|------------|-------------------|
| damper | yes | Non-linear | Spline | yes | Non-linear | Spline | Dampers - 2nd set |
| damper_2 | no | Non-linear | Spline | no | Non-linear | Spline | |

Figure34: Correction of dampers data of “Adams Chassis” Library

| Name | Left Value | Right Value | Comment |
|-------------------|------------|-------------|--|
| column_to_housing | 0.0 | | Column to Housing Viscous Damping (N-sec/deg) |
| compliance | 9001.0 | | Steering Column Compliance (N-sec/deg) - Construction Option |
| damping | 47.37 | | Steering Column Damping (N-sec/deg) |
| shaft_torsion | 0.0 | | Lash in Intermediate Shaft Slip Joint (deg) |
| slip_rate | 17450.0 | | Rate in Slip Joint (N-sec/deg) (not used if Lash=0) |

Figure35: Validated data for Steering System Section of “Adams Chassis” Library

Results of running “Ride Motion” and “Front Steering” tests are brought in Figures 36 and 37.

===== ADAMS FRONT STEERING TEST RESULTS =====

*** VEHICLE PERFORMANCE ***

| Characteristics | Left | Right | Average |
|--------------------------|-------|--------|-----------------|
| Max Steering Ratio | 19.56 | -17.42 | 18.49 (deg/deg) |
| Min Steering Ratio | 17.42 | -19.56 | 18.49 (deg/deg) |
| Overall steering Ratio | 18.97 | -18.52 | 18.74 (deg/deg) |
| on center steering Ratio | 19.20 | -19.15 | 19.17 (deg/deg) |

Figure36: Front Steering Test Results

===== ADAMS FRONT RIDEMOTION TEST RESULTS =====

*** FRONT TIRE ORIENTATION ANGLES ***

| | | |
|----------------------------|---|--------------|
| Maximum Left Toe Angle | = | 3.102 (deg) |
| Minimum Left Toe Angle | = | -3.000 (deg) |
| Maximum Left Caster Angle | = | 5.084 (deg) |
| Minimum Left Caster Angle | = | 4.437 (deg) |
| Maximum Left Camber Angle | = | -3.215 (deg) |
| Minimum Left Camber Angle | = | -2.998 (deg) |
| Maximum Right Toe Angle | = | 3.102 (deg) |
| Minimum Right Toe Angle | = | -3.000 (deg) |
| Maximum Right Caster Angle | = | 5.084 (deg) |
| Minimum Right Caster Angle | = | 4.437 (deg) |
| Maximum Right Camber Angle | = | -3.215 (deg) |
| Minimum Right Camber Angle | = | -2.998 (deg) |

*** Properties At Curb ***

| | | |
|---------------------------------|---|----------------|
| Initial wheel Travel (curb) | = | 0.000 (mm) |
| Left wheel Rate | = | 6.817 (N/mm) |
| Left wheel Force | = | 500.352 (N) |
| Left wheel:Spring motion ratio | = | 0.563 (ratio) |
| Left wheel:Damper motion ratio | = | 0.563 (ratio) |
| Left Anti-Dive | = | 9.533 (%) |
| Left Anti-Lift | = | 0.000 (%) |
| Left Toe | = | -3.000 (deg) |
| Left Caster | = | 4.747 (deg) |
| Left Camber | = | -0.503 (deg) |
| Left Toe/wheel Travel | = | -4.975 (deg/m) |
| Left Recession | = | 0.002 (mm) |
| Right wheel Rate | = | 6.817 (N/mm) |
| Right wheel Force | = | 500.291 (N) |
| Right wheel:Spring motion ratio | = | 0.563 (ratio) |
| Right wheel:Damper motion ratio | = | 0.563 (ratio) |
| Right Anti-Dive | = | 9.533 (%) |
| Right Anti-Lift | = | 0.000 (%) |
| Right Toe | = | 3.000 (deg) |
| Right Caster | = | 4.747 (deg) |
| Right Camber | = | -0.503 (deg) |
| Right Toe/wheel Travel | = | 4.974 (deg/m) |
| Right Recession | = | -0.004 (mm) |
| Roll Center Z Height | = | 31.478 (mm) |
| Roll Center Y Position | = | 0.012 (mm) |

Figure37: Ride motion Test Results

As it can be seen “Adams Chassis” librarian and simulation results did not cover enough data for validation. By getting help from data bases of calculator tools remaining parameters will be identified. For suspension factors (front and rear) “Circle Track Analyzer” applied. Main and related pages of front and rear suspension are shown in Figures 38-40.

Circle Track Analyzer v3.6 Performance Trends [LATEMODL355]

File (vehicle) Results Help Preferences Reg To: unregistered copy

Open Vehicle Library Calculate Lap Times Find Best Gear Ratio Help

Save Vehicle to Library Match My Lap Times Quit Program Corner Weights

Vehicle Specs

Engine

Vehicle

Front Suspension

Rear Suspension

Running/Track Conditions

Vehicle Summary

Engine File: untitle 355.1 cubic inches
444 lbs at 5000 RPM and 487 HP at 6500 RPM

Weight: 2800 lbs (50% rear, 50% left, 50% cross)
Axle Ratio: 5.1 Rear Tires: 82" and 85" circumference

Front Susp. File: latemodl.fab Double A Arm with Coil Springs Track: 64.0"
Rt Spring: 350 Lt Spring: 325 Rt Camber: -3 Lt Camber: 2.5

Rear Susp. File: leaf-spring for Leaf Springs
Track: 61.0" Lt Spring: 200 Rt Spring: 200

Comments:
Super Late Model on a 1/2 mile track with fabricated front and rear suspension.
487 HP at 6500 from 355 w 390 4BBL, roller cam, AFR

Transition Handling Rating

Click here to update these Handling Ratings

Report on Details Help

Find 'Classic' Handling

Show 'Dynamic' Handling

Figure38: Main page of “Circle Track Analyzer” Tool

Approaching Influence of Vehicle's Properties in Crosswind and Overtaking Situations Using Multi-Step Taguchi Method

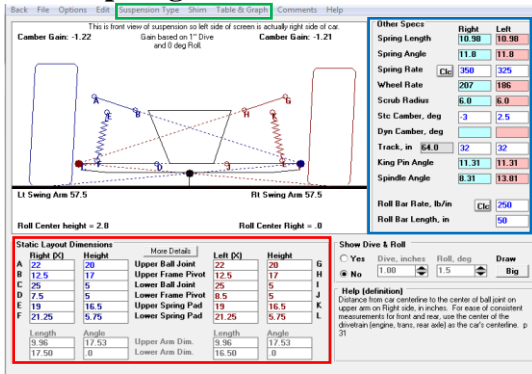

Figure39: Front suspension section in “Circle Track Analyzer” tool

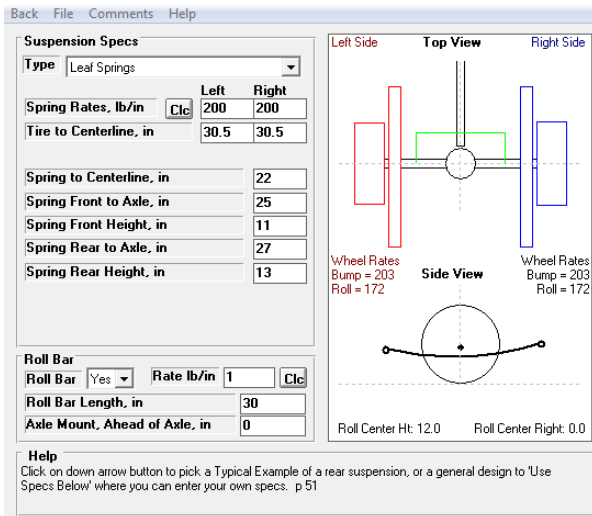

Figure40: Rear suspension section on “Circle Track Analyzer” tool

Regarding to Figure 38, after inserting van's data base from green box and setting test and track conditions in red box option, validation of suspension parameters can be available. By selecting each switch mentioned with blue box front and rear suspension pages are accessible. As it can be seen in Figure 39 in order to have the most accuracy it is possible to correct any geometric parameters in red box from validated “Adams Chassis” data before. Also suspension types and Toe-Camber graphs are accessible in green box section. Results of applying this tool are given in Table 5 and 6.

Table5: “Circle Track Analyzer” Front suspension results

| Parameter | Unit | Value |
|--|--------------------|----------|
| Spring Mechanical Ratio | - | 0.81 |
| Damper Mechanical Ratio | - | 0.81 |
| Jounce and Rebound Ratio | - | 500 |
| Auxiliary Roll Moment | <i>N.m/deg</i> | 0.000003 |
| Auxiliary Roll Damping | <i>N.m.sec/deg</i> | 0.000035 |
| Longitudinal Displacement VS F_x | <i>mm/N</i> | 0 |
| Longitudinal Displacement VS F_y | <i>mm/N</i> | 0 |
| Inclination VS F_x | <i>deg/N</i> | 0 |
| Inclination VS F_y | <i>deg/N</i> | 0 |
| Inclination VS M_z | <i>deg/N</i> | 0 |

Table6: “Circle Track Analyzer” Front suspension results

| Parameter | Unit | Value |
|-----------------------------|----------|-------|
| Mass | Kg | 155 |
| Roll and Yaw Inertia | $Kg.m^2$ | 50 |
| Spin Inertia | $Kg.m^2$ | 1.5 |
| Static Toe Angle | deg | 0.2 |
| Static Camber Angle | deg | 1.079 |

For steering parameters “Steering Geometry Simulation” tool is used. As it presented in Figures 41 and 42, by inserting geometry data of steering column (which is validated before in “Adams Chassis”) required data are given in Table 7.

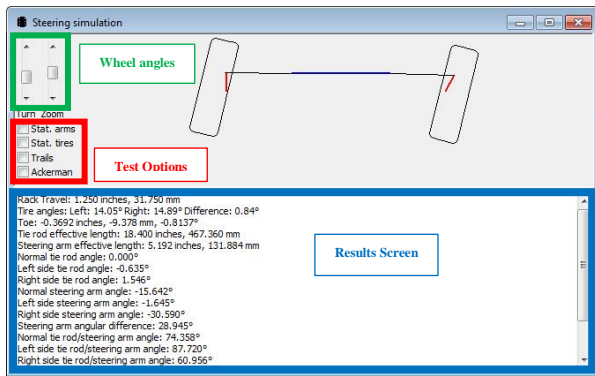

Figure41: Main page and its setting of “Steering Geometry Simulation: tool

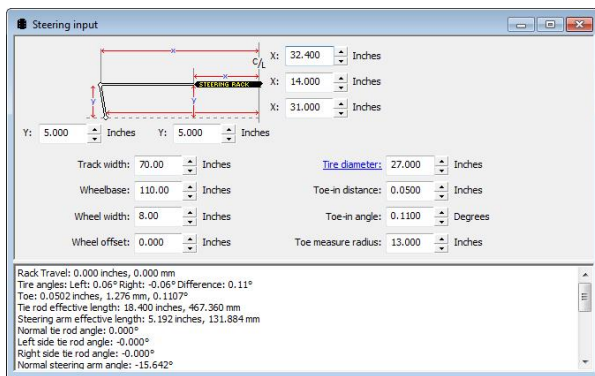

Figure42: Inserting steering geometry data in “Steering Geometry Simulation” tool

Table7: Results of Simulation in “Steering Geometry Simulation” Tool

| Parameter | Unit | Value |
|--------------------------|-------------------|---------|
| Column Inertia | Kg.m ² | 0.025 |
| Steering System Inertia | Kg.m ² | 0.00018 |
| Column Damping | N.m.sec/deg | 0.02 |
| Gear Ratio | deg/deg | 19.80 |
| Center offset of Kingpin | mm | 42.50 |
| Inclination of Kingpin | deg | 5.00 |
| Caster Angle | deg | 3.00 |
| Torsion Bar Stiffness | N.m/deg | 2.20 |

2.4. Calculation of Lateral Deviation Error

To find out deviation error or similarity of two vector of arrays as one rational number format, dozens of methods have been proposed and in

mathematical and genetics fields [16]. Most of these methods based on giving a percentage value of having 0 or 1 for being different or exact similar respectively. These methods cannot be applied in this study since the length of vectors might be different and also being exact equal between i-th number two arrays is almost zero. So in this study, we managed to use “Pairwise distance between two sets of observations” like “Minkowski calculator” method which one can apply by “D= pdist2” command in MATLAB program [17]. To use this method 2 steps of process must be done. First “Vehicle Lateral Traction” and “Lateral Target” vectors for time steps of 0.01s must be calculated from CarSim plots. Second apply following Matlab code:

$$D = \text{pdist2} \left(\begin{matrix} \text{Vehicle Lateral Traction vector,} \\ \text{Lateral Target Vector, 'Minkowski'} \end{matrix} \right) \quad (1)$$

Which Minkowski method is:

Minkowski Metric =

$$d_{st} = \sqrt[p]{\sum_{j=1}^n |V_j - T_j|^p} \quad p = 2 \quad (2)$$

2.5 Level Designing for Multi Step Taguchi

Back to parameter validation sections, it can be concluded that classes have 1 to 9 factors. Due to limitation of MINITAB program for Taguchi designing and huge number of factors, multi step usage of Taguchi method is the only way to solve the problem. Besides 3 levels are the utmost steps it can be considered in each step. To find a proper data interval for levels in each factor, “Tolerance Interval Tool” in MINITAB software applied. As an example Factor “Tire Width” for proposed vehicle given by Vehicle Standard Guideline is limited between 185mm to 265mm [14]. These data consider as interval borders. Next step it should bring available data within the borders for this factor by using Standard Guidelines [14],[19] (or librarian data base and random choices). Important note for this step is intervals data must not interfere with vehicles geometry and dynamics. By proceeding Tolerance Interval Tool, 6σ intervals resulted. In this research (-σ, σ) and (-2σ, 2σ) intervals applied for first and second step of Taguchi respectively. Figures 43and 44 show the results of this example.

Approaching Influence of Vehicle's Properties in Crosswind and Overtaking Situations Using Multi-Step Taguchi Method

| ↓ | C1 | C2 | C |
|----|-----------------|----------|---|
| | Tire Width (mm) | D=pdist2 | |
| 1 | 185 | 0.725 | |
| 2 | 205 | 0.662 | |
| 3 | 215 | 0.662 | |
| 4 | 225 | 0.660 | |
| 5 | 235 | 0.658 | |
| 6 | 245 | 0.657 | |
| 7 | 250 | 0.655 | |
| 8 | 265 | 0.600 | |
| 9 | * | | |
| 10 | | | |

Figure43: Tire width interval

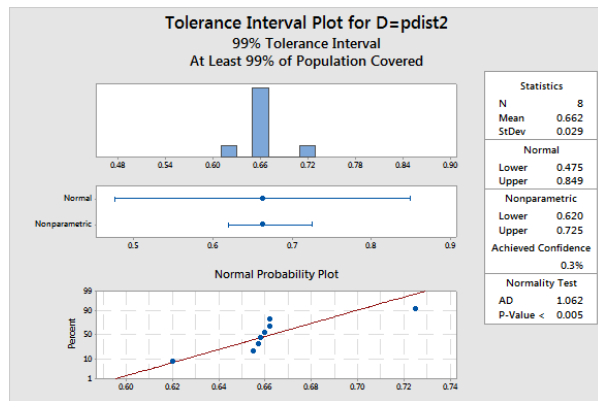

Figure44: Tolerance Interval Plot for D Value

By having mean and standard deviation of “D Value” calculating 6σ intervals and finding related intervals for Taguchi steps is done. Table 8 shows these process.

Table8: 6σ intervals for D value and Taguchi Steps

| Taguchi Step | 6σ | D Value Intervals | Tire Width Interval |
|----------------------|-----------------------|-------------------|---------------------|
| First Step | $(-\sigma, \sigma)$ | (0.633,0691) | (205,255) |
| 2 nd Step | $(-2\sigma, 2\sigma)$ | (0.604,0.72) | (185,265) |
| Third Step | $(-3\sigma, 3\sigma)$ | (0.575,0.749) | NAN |

The “NAN” value refers when boundaries of related interval of “D Value” for Tire width is larger than 185mm and 265mm and means this interval interfere with vehicles dynamic and geometry.

2.6 Classification of Factors

In this section first a brief view of classes and their number of factors given in Table9.

Table9: Categorized Classes of vehicle

| Class | No of Factors | |
|-------|-------------------------|----|
| 1 | Sprung Mass Properties | 4 |
| 2 | Tire Properties | 7 |
| 3 | Aerodynamics Properties | 9 |
| 4 | Steering Properties | 13 |
| 5 | Suspension Kinematics | 13 |
| | Suspension compliance | 15 |
| 6 | Brakes | 4 |
| 7 | Engine Properties | 4 |
| 8 | Test options | 2 |

Detailed Classes and their factors are brought in Tables 10-19.

Table10: Sprung Mass Classification

| Factors | |
|---------|--|
| 1 | Sprung Mass |
| 2 | CG Height of Sprung Mass |
| 3 | Longitudinal Distance of CG of Sprung Mass |
| 4 | Lateral Distance of CG of Sprung Mass |

Table11: Tire Classification

| Factors | |
|---------|--------------------------|
| 1 | Tire Type |
| 2 | Tire Radius |
| 3 | Tire Width |
| 4 | Maximum Allowed Force |
| 5 | Spring Rate of Tires |
| 6 | Cut off Speed |
| 7 | Effective Rolling Radius |

Table12: Aerodynamic Classification

| Factors | |
|----------------|--------------------------|
| 1 | Frontal Area |
| 2 | Air Density |
| 3 | Crosswind Degree |
| 4 | Drag Coefficient |
| 5 | Lift Coefficient |
| 6 | Side Force Coefficient |
| 7 | Roll Moment Coefficient |
| 8 | Pitch Moment Coefficient |
| 9 | Yaw Moment Coefficient |

Table13: Steering Classification

| Factors | |
|----------------|--|
| 1 | Kingpin Inclination Angle |
| 2 | Front Steering Compliance |
| 3 | Rear Steering Compliance |
| 4 | Torsion Bar Stiffness |
| 5 | Front Steering Damping |
| 6 | Steering Gear Ratio |
| 7 | Steering System Type |
| 8 | Kingpin Lateral Offset from Center (Front) |
| 9 | Kingpin Lateral Offset from Center (Rear) |
| 10 | Steering Column Inertia |
| 11 | Steering System Inertia |
| 12 | Steering Column Damping |
| 13 | Steering Column Hysteresis |

Table14: Suspension Kinematics Classification

| Factors | |
|----------------|---|
| 1 | Spin Inertia for each side of Suspension |
| 2 | Lateral Distance between two wheels of Axle |
| 3 | Static Front Toe Angle |
| 4 | Static Rear Toe Angle |
| 5 | Static Front Camber Angle |
| 6 | Static Rear Camber Angle |
| 7 | Static Front Caster (dive) Angle |
| 8 | Static Rear Caster (dive) Angle |
| 9 | Axle Roll and Yaw Inertia |
| 10 | Jounce at Design Load |
| 11 | Wheel Center Height |
| 12 | Lateral Coordinate of Suspension Axle |
| 13 | Unsprung Mass |

Table15: Suspension Compliance Classification

| Factors | |
|----------------|--|
| 1 | Suspension Spring Type |
| 2 | Mechanical Ratio of Suspension Component |
| 3 | Front Spring Alone Type |
| | Front Ride Rate Spring Type |
| 4 | Rear Spring Alone Type |
| | Rear Ride Rate Spring Type |
| 5 | Front Jounce and Rebound Stops |
| 6 | Rear Jounce and Rebound Stops |
| 7 | Auxiliary Roll Moments |
| 8 | Lateral Distance between Springs of Axle |

Approaching Influence of Vehicle's Properties in Crosswind and Overtaking Situations Using Multi-Step Taguchi Method

| | |
|----|---|
| 9 | Lateral Distance between Dampers of Axle |
| 10 | Lateral Distance between Rebounds of Axle |
| 11 | Lateral Distance between Jounces of Axle |
| 12 | Upper Seat Height Adjustment |
| 13 | Front Damper Type |
| 14 | Rear Damper Type |
| 15 | Auxiliary Roll Damping |

Table16: Brake Classification

| Factors | |
|---------|------------------------------------|
| 1 | Maximum Front Brake Torque |
| 2 | Maximum Rear Brake Torque |
| 3 | Front Fluid Pressure Proportioning |
| 4 | Rear Fluid Pressure Proportioning |

Table17: Engine Classification

| Factors | |
|---------|----------------------------------|
| 1 | Horsepower of Engine |
| 2 | Torque of Engine |
| 3 | Internal Differential Gear Ratio |
| 4 | Wheel Drive (WD) |

Table18: Test Options Classification

| Factors | |
|---------|---------------------------------|
| 1 | Test Speed of Vehicle |
| 2 | Wind Speed (Overtaking Vehicle) |

For Verification of final results, a statistical field research which has been done by giving an e-questionnaire we developed by Telegram Bots and sharing it with 100 graduate and undergraduate mechanical engineers of Ferdowsi University of Mashhad. By using this method we saved paper works and time. This questionnaire bot given the user a multi-choice access throw 39 options simultaneously and in order to prevent cheating and fake votes, it developed to delete votes of a user who enter the bot more than one time.

3. Results and Discussions

As it was discussed in previous section, in order to apply Taguchi Method in MINITAB software it is obligated to categorize vehicle's parameters to smaller classes which was presented in Table 5. The Results of using Taguchi for each class have shown in Figures 45-54. Then they were arranged these top ones in Table 6, and apply another step of Taguchi method for final and most effective parameters in crosswind and overtaking conditions for our proposed van.

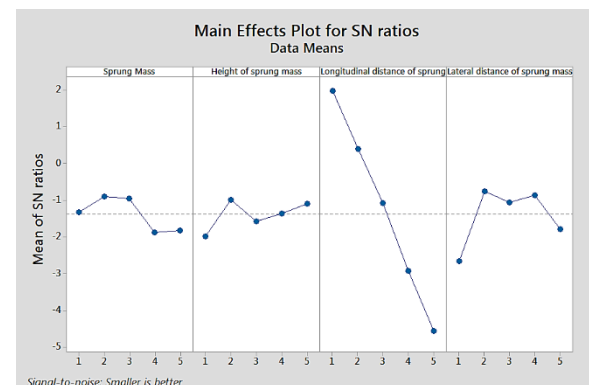

Figure45: Taguchi SNR plot for Sprung Mass properties

It can be concluded from Figure 45 that "Longitudinal Distance of Sprung mass" and after that "Lateral Distance of sprung mass" are more effective parameters in Class 1 categories and height of sprung mass and sprung mass itself are less effective. The goal of Signal-Nosie (SNR) plot in this study is "smaller is better" so if one reach the biggest SNR it will closer to the goal. So being in Level 1 in "longitudinal distance of sprung mass" factor, Level 2 in "Lateral distance of sprung mass" factor, Level 2 for "Height of sprung mass" and "sprung mass" it will get the best result.

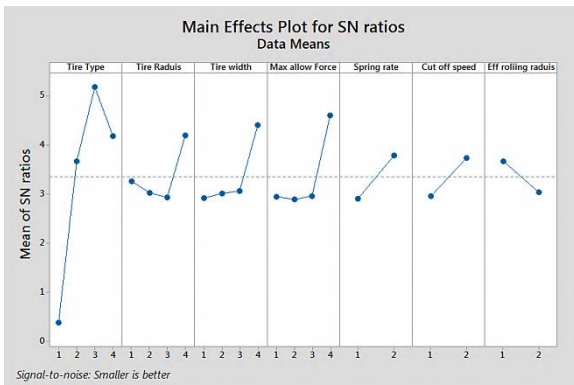

Figure46: Taguchi SNR plot for Tire properties

Here we can find from Figure 46 that “Tire type” and after that “Tire width, radius and Maximum allow force” are more effective parameters in Class 1 categories and cut off speed and effective rolling radius are less effective. As choosing is “smaller is better” goal for this study so if we reach the biggest SNR we will closer to our goal. So being in Level 3 in “Tire type” factor, Level 4 in “Tire width, radius and maximum allowed force” factor, the best results can be driven.

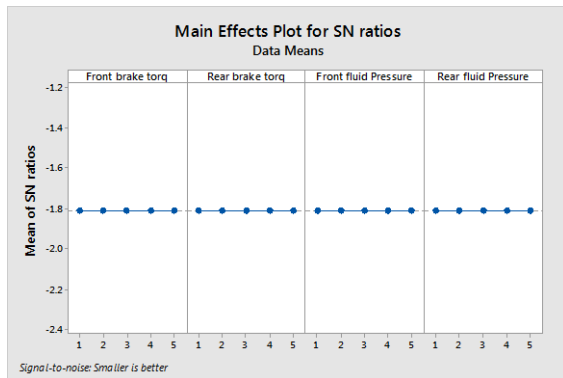

Figure47: Taguchi SNR plot for Brake properties

From Figure 47 one can concluded that Brake properties have no effect on lateral deviation of vehicle in crosswind and overtaking situation.

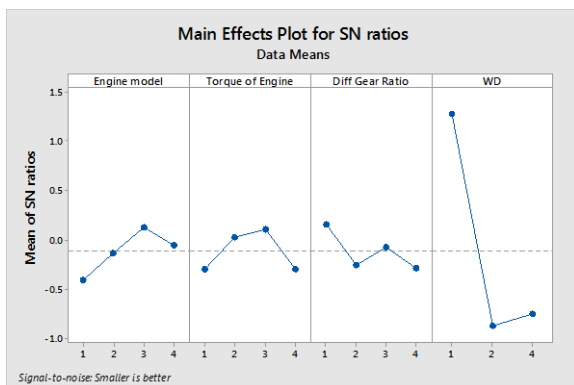

Figure48: Taguchi SNR plot for Engine properties

It can be obtained from Figure 48 that “Wheel Drive Type” is the most effective parameters in Class 1 categories and others are less effective. Because our goal in Taguchi method here is “smaller is better” so if one reach the biggest SNR we will closer to the goal. So being in Level 1 in “WD” factor, Level 3 in “Engine Model and maximum torque of engine” factors, the best result can be received.

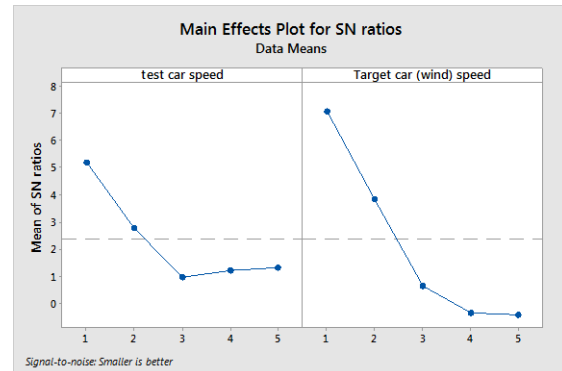

Figure49: Taguchi SNR plot for Test Options (Crosswind Test)

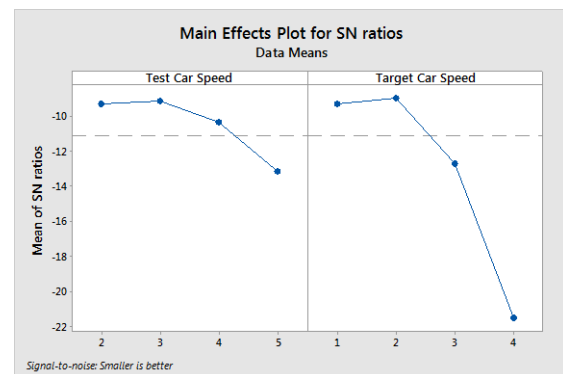

Figure50: Taguchi SNR plot for Test Options (Overtaking)

“Test Option” class divided to 2 parts, part one which is crosswind conditions applied and we can derive from its SNR plot in Figure 49 that both wind and car speed are effective, and part two which is overtaking conditions happens and it can be deduced that Target vehicle’s Speed has more effect in our test vehicle’s deviation and that’s because of strong air vortex it generate at its sides and backs when it gives more speed respectively. But for final Taguchi we concern both of them as effective factors.

Approaching Influence of Vehicle's Properties in Crosswind and Overtaking Situations Using Multi-Step Taguchi Method

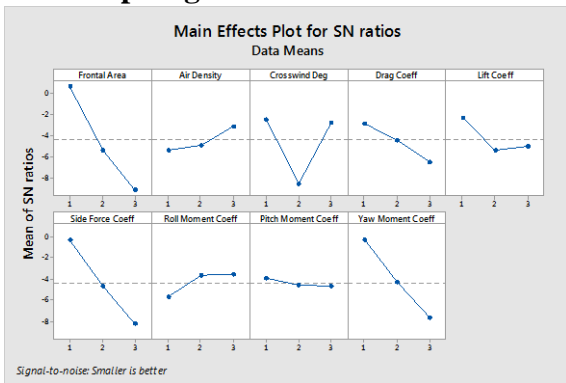

Figure51: Taguchi SNR plot for Aerodynamic properties

Regarding to Figure 51 SNR plot we can conclude that these four factors are the most effective parameters among the 9 aerodynamic properties: 1) Frontal Area 2) Yaw moment coefficient 3) Slide Moment and degree of crosswind at end.

camber angle 3)jounce at design load. And because in our Taguchi method is “smaller is better” so if one reach the biggest SNR it will closer to our goal. So being in Level 3 in “Static Font toe angle” factor, Level 1 in “static front camber angle” factor, and Level 1 for “jounce at design load”, the best results can be given.

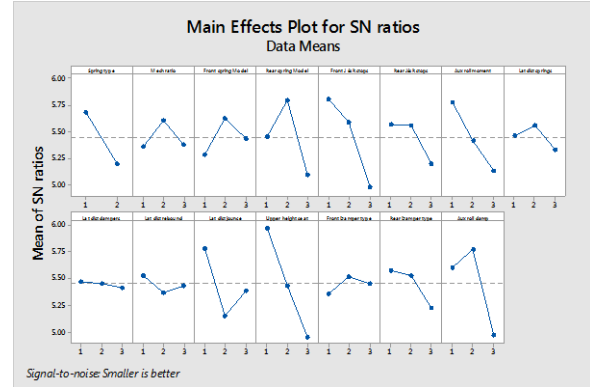

Figure54: Taguchi SNR plot for Suspension Compliance properties

According to Figure 54 SNR plot we can conclude that these four factors are the most effective parameters among the 13 aerodynamic properties:1)Upper spring seat height 2)Front Jounce & Rebound stops 3)Auxiliary roll moment Because our goal in Taguchi method here is “smaller is better” so if we reach the biggest SNR we will closer to our goal. So setting in Level 1 in for effective ones we can get the best result.

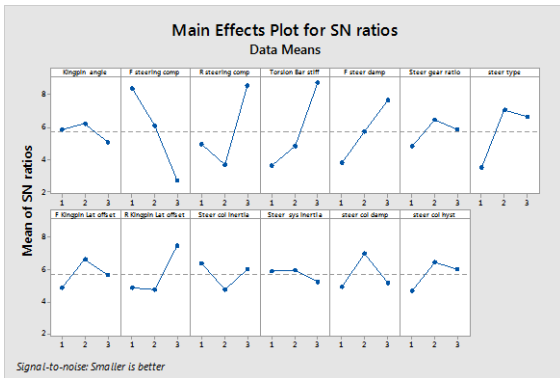

Figure52: Taguchi SNR plot for Steering properties

Due to Figure52 it can be deduced that these four factors are the most effective parameters among the 13 steering properties we have:1)Front steer compliance 2)Torsion bar stiffness 3)Front steer damping.

In Table 19 all the effective factors from each class to applying Taguchi Method gathered once again. As it is shown 72 parameters that taught might have effects in crosswind and overtaking conditions reduced into 21 parameters. But for future works and optimization it is obligated to decrease the number of factors. The result of using Final Taguchi application presented in Figure 55 and Table 20.

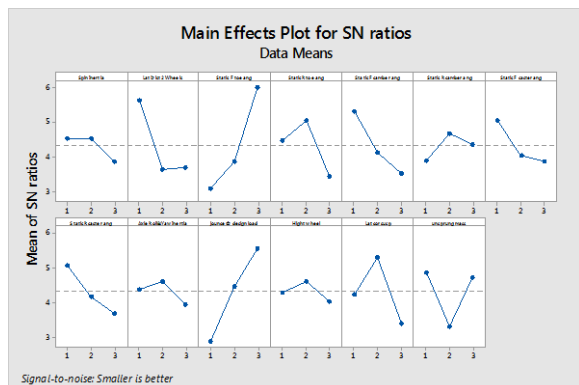

Figure53: Taguchi SNR plot for Suspension kinematics properties

According to Figure 53 it can be inferred that these four factors are the most effective parameters among the 13 aerodynamic properties we get: 1)Static Font toe angle 2)static front

Table19: 21 Effective Parameters from Primary Taguchi Method

| | Class | Effective Factors |
|---|------------------------|--------------------------------------|
| 1 | Sprung mass properties | Longitudinal Distance of Sprung mass |
| 2 | Tire Properties | Tire Type |
| | | Tire width |
| | | Tire Radius |
| 3 | Brakes Properties | - |
| 4 | Engine Properties | Wheel Drive Type |
| 5 | | Test car speed |

| | | |
|---|----------------------------------|------------------------------|
| 5 | Test Option Properties | Wind (Target car) speed |
| 6 | Aerodynamics Properties | Frontal Area |
| | | Side force coefficient |
| | | Yaw moment coefficient |
| | | Crosswind degree |
| 7 | Steering Properties | Front steer compliance |
| | | Torsion bar stiffness |
| | | Front steer damping |
| 8 | Suspension Kinematics Properties | Static Front toe angle |
| | | Static front camber angle |
| | | Jounce at design load |
| 9 | Suspension compliance Properties | Upper spring seat height |
| | | Front Jounce & Rebound stops |
| | | Auxiliary roll moment |
| | | Auxiliary roll damping |

| | | |
|---|----------------------------------|------------------------------|
| 3 | Aerodynamics Properties | Side force coefficient |
| | | Frontal Area |
| | | Crosswind degree |
| 4 | Steering Properties | Front steering compliance |
| 5 | Suspension Kinematics Properties | Jounce at design load |
| | | Static Front toe angle |
| | | Static front camber angle |
| 6 | Suspension compliance Properties | Upper spring seat height |
| | | Front Jounce & Rebound stops |

These most effective factors are categorized based on their “D Value” to indicate their sensitivity, it is shown in figure 56 scaled on number 15.

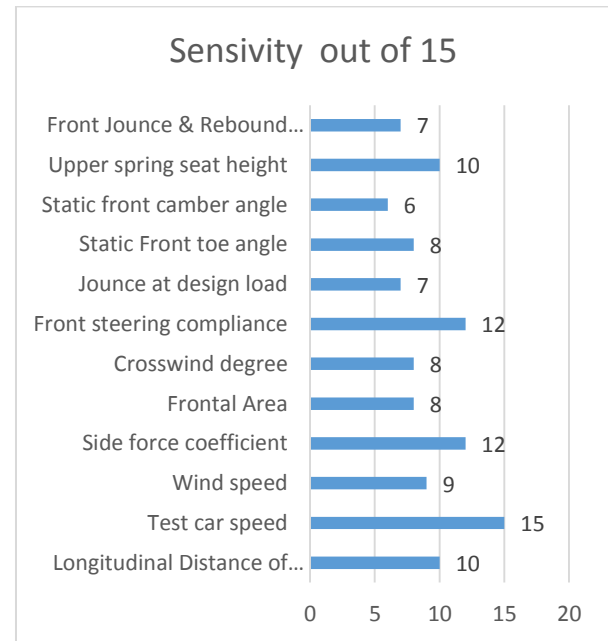

Figure56: Sensitivity of most effective factors of crosswind conditions

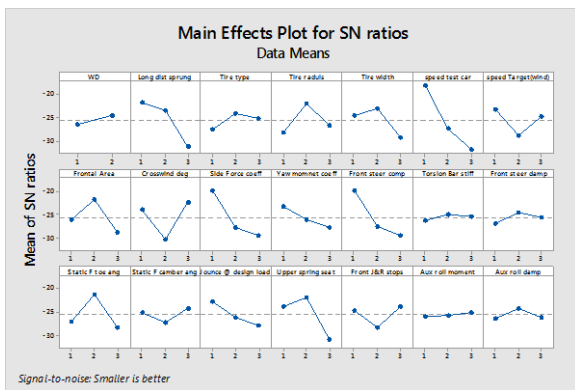

Figure55: Final Taguchi SNR plot

Table20: The Most Effective Vehicle’s Parameter in Crosswind or Overtaking

| | Class | Most Effective Factors |
|---|--------------------------------------|--------------------------------------|
| 1 | Longitudinal Distance of Sprung mass | Longitudinal Distance of Sprung mass |
| 2 | Test Option Properties | Test car speed |
| | | Wind (Target car) speed |

In this study, in order to verify our results we get help from previous studies and a statistical fieldwork mentioned before. Mansor et al. by deriving vehicle’s lateral dynamics found that these 6 parameters are the most effective factors in crosswind deviation [18]:

- 1) Vehicle’s speed
- 2) Wind Speed
- 3) Crosswind angle
- 4) Rear Slant Angle
- 5) Side Force Stiffness of Chassis
- 6) Side Force Damping of Chassis

In a similar study, Juhlin et al. Found the effect of 22 vehicle’s parameter on the lateral deviation due to crosswind [19] which they presented in the follow Figure 57:

Approaching Influence of Vehicle's Properties in Crosswind and Overtaking Situations Using Multi-Step Taguchi Method

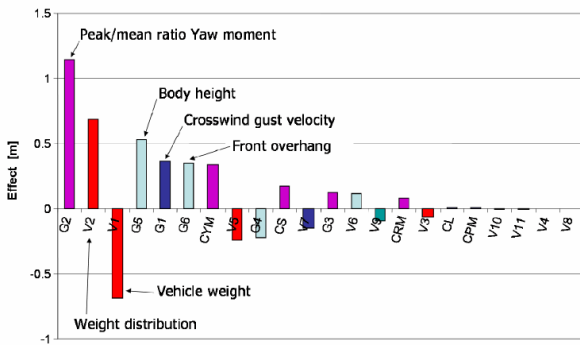

Figure 57: effect of 22 vehicle's parameter on the lateral deviation due to crosswind [19]

Besides the CFD studies that have done up today and focusing on aerodynamic properties, the results of our studies not only covers all the available vehicle's parameters from aerodynamic to wheel drive types factors, but also previous relative study as well. It should be noted that our results are also supported by field statistical results which it is shown in Figure 58.

4. Conclusion

In this study in order to find the most effective parameters among Crosswind and Overtaking situations for long vehicles like buses, trucks and vans, a specific Van modeled for this research in CarSim program and validate the parameters by getting help from other simulations programs, program's library and vehicle's manual data provided by its company.

To find the proper levels for each factor we proposed the Tolerance Interval Tool in MINITAB application and to find the value of similarity vehicle's path versus original path in test situation we presented the Euclidean Distance formula so we could run Taguchi method. But we found the computational problem for running these vast of factors and levels so we hadn't another choice but to categorize factors to smaller classes and run Taguchi for primary classes and once again with top ones of each class and reduced the effective parameters into only 12 factors.

Involving with these most effective factors instead of working tons of vehicle's parameters in crosswind and overtaking conditions for body designing of large vehicles, designing controllers and optimization can be huge help. Reduction of frontal area and optimization of Longitudinal Distance of CG, Knowing the body's pressure points (Figure7) for installing crosswind sensors and Designing Electronic Crosswind Controller (ECC) by having these most effective factors as input channels are parts of this research conclusion.

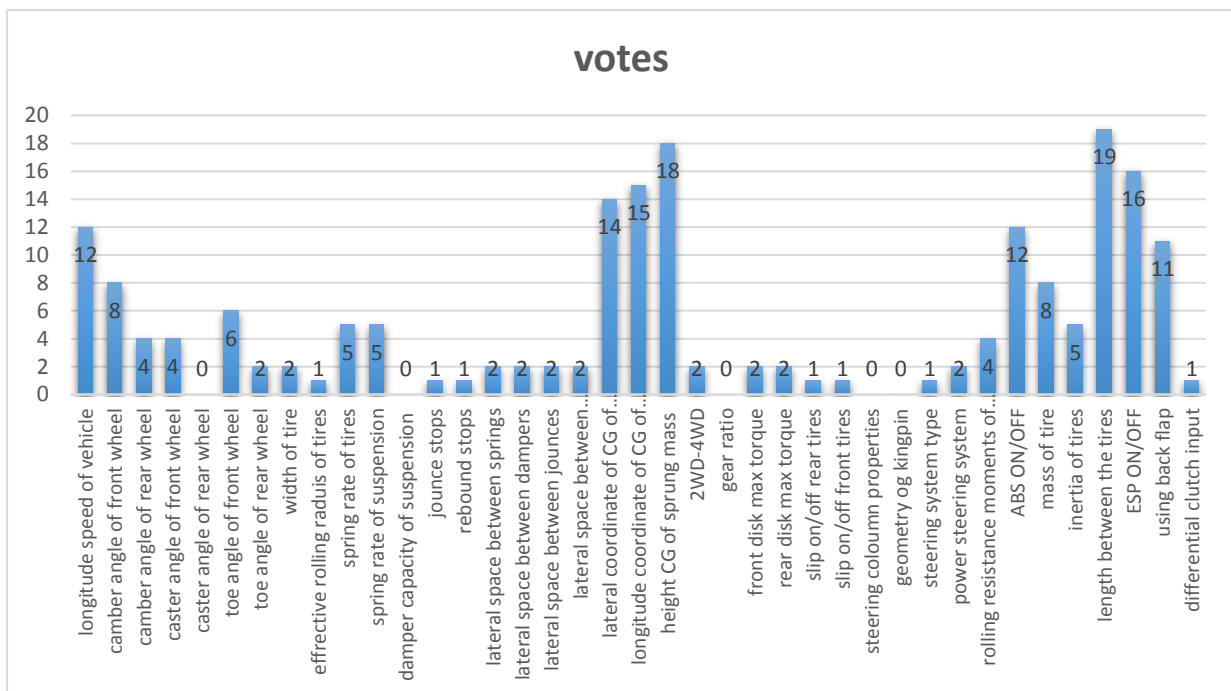

Figure 58: Result of Statistical work field by e-Questionnaire

References

- [1] Xiaoxiang Ma et al., Examining the safety of trucks under crosswind at bridge-tunnel section: A driving simulator study, *Tunnelling and Underground Space Technology*, 92 (2019) 103034.
- [2] Vehicle Crosswind Stability. Chrysler Challenge Fund Project - #2000533, UMTRI, Sponsored by the Chrysler Motors Corporation, 1987-1990.
- [3] Huoyue Xiang et al., A wind tunnel test method on aerodynamic characteristics of moving vehicles under crosswinds, *Journal of Wind Engineering & Industrial Aerodynamics* 163 (2017) 15–23.
- [4] Takuji Nakashima et al., Coupled analysis of unsteady aerodynamics and vehicle motion of a road vehicle in windy conditions, *Computers & Fluids* 80 (2013) 1–9.
- [5] Yan Han et al., New analytical models for power spectral density and coherence function of wind turbulence relative to a moving vehicle under crosswinds, *Journal of Wind Engineering & Industrial Aerodynamics* 188 (2019) 384–396.
- [6] Raffaele Volpe et al., Forces and flow structures evolution on a car body in a sudden crosswind, *Journal of Wind Engineering and Industrial Aerodynamics*, (2014) 114–125.
- [7] A. Watari, S. Tsuchiya and H. Iwase, On the Cross-Wind Sensitivity of the Automobile. Proceedings of the 15th FISITA Congress, Paris, 1974
- [8] G. Chen, K.J. Fidkowski, Discretization error control for constrained aerodynamic shape optimization, *J.Comput. Phys.* (2019)
- [9] Guangsheng Du et al., Transient aerodynamic characteristics of vans overtaking in crosswinds, *Journal of Wind Engineering & Industrial Aerodynamics* 170 (2017) 46–55.
- [10] M. Sayers, C. C. MacAdam and Y. Guy, Chrysler/UMTRI Wind-Steer Vehicle Simulation. User's Manual, Version 1.0, vols I and II, Report No. UMTRI-89-811-2, 1989.
- [11] C. Acosta L«ua, S. Di Gennaro, Nonlinear Adaptive Tracking for Ground Vehicles in the Presence of Lateral Wind Disturbance and Parameter Variations, *Journal of the Franklin Institute* (2017).
- [12] Mahdi Azarpeyvand et al., Design and performance of an aeroacoustic wind tunnel facility at the University of Bristol, *Applied Acoustics* 155 (2019) 358–370.
- [13] Carsten Proppe, Xiaoyu Zhang, Influence of Uncertainties on Crosswind Stability of Vehicles, IUTAM Symposium on “Dynamical Analysis of Multibody Systems with Design Uncertainties”, (2015) 98 – 107.
- [14] Niklas Winkler, Lars Drugge, Annika Stensson Trigell, Gunilla Efraimsson, Coupling aerodynamics to vehicle dynamics in transient crosswinds including a driver model, *Comput-ers and Fluids* (2016).
- [15] Mercedes-Benz USA,LLC/Dialmer Vans USA LLC, Body and Equipment (BEG) SPRINTER 2016/2017
- [16] Antara Ghosh, Soma Barman, Application of Euclidean distance measurement and principal component analysis for gene identification, *Gene*, Volume 583, Issue 2, 2016, Pages 112-120
- [17] The Technical Whitepaper series, Series 6, Euclidean Distance raw, normalized, and double-scaled coefficients,2005
- [18] S. Mansor, M. R. Rahman, M.A. Passmore, Dynamic Simulation of Vehicle Crosswind Sensitivity for Various Rear Slant Angle, *International journal of automotive technology* 14 (5), 701-706
- [19] Magnus Juhlin and Peter Eriksson, A vehicle parameter study on crosswind sensitivity of buses, *Commercial Vehicles Engineering Congress and Exhibition*, Rosemont, Illinois, October 26-28, 2004.