

Hybrid energy storage optimal sizing for an e-bike

M. Masih-Tehrani¹, V. Esfahanian², M. Esfahanian³, H. Nehzati², M.J. Esfandiari²

1 School of Automotive Engineering, Iran University of Science and Technology, Tehran, Iran 2 School of Mechanical Engineering, University of Tehran, Tehran, Iran 3 Department of Mechanical Engineering, Isfahan University of Technology, Isfahan, Iran

Abstract

The Energy Storage System (ESS) is an expensive component of an E-bike. The idea of Hybrid Energy Storage System (HESS), a combination between battery and Ultra-Capacitor (UC), can moderate the cost of E-bike ESS. In this paper, a cost function is developed to use for optimal sizing of a HESS. This cost function is consisted of the HESS (battery, UC and DC/DC converter) cost and the cost of battery replacements during 10 years. The battery lifetime and riding pattern limit the life span of ESS. The "Portuguese standard NP EN 1986-1" riding pattern is used in this research. The Genetic Algorithm (GA) is used to solve the optimization problem. The results show that the cost and weight of HESS are clearly better than optimally sized battery ESS.

Keywords: E-Bike, Energy Storage Price, Hybrid Energy Storage System, Optimization

1. Introduction

As a cost-effective, healthy, and environmentally friendly personal mode of transportation, electric bicycles (e-bikes) are gaining an increasing market share from conventional bicycles and automobiles. The on-board energy source is typically an electro-chemical battery and this important technology is the one that has slowed down the development of the e-bike. However, with its continued development, there become more and more opportunities for e-bike, on the grounds of cost, reliability and lifetime [1].

The life of battery as well as the cost of replacing them is a key drawback of battery and electric device as e-bike [2]. Sousa et.al. [3] Proposed a combination of two sources of energy, batteries and Ultra-Capacitors (UC), as a Hybrid Energy Storage System (HESS) for an e-bike. A HESS has high energy and high power specifications, in contrast to battery or UC separately. The main objective of coupling batteries and UCs is to reduce the current stress in the batteries and to improve its life-time [4]. The main drawback of the HESS is its cost. Therefore, the sizing optimization is necessary.

In this paper, the powertrain of e-bike and the resistance loads are modelled. Then the powertrain design is done. In next section, a fitness function for

optimum sizing of e-bike ESS is developed. The fitness function consists initial cost of ESS and replacement of battery, which is needed in the lifespan of the e-bike (10-years). The battery ESS and HESS optimal sizing problems are solved separately. The HESS optimal sizing problem is solved by Genetic Algorithm (GA) method.

2. E-bike modeling

The e-bike powertrain model is developed in MATLAB/Simulink. The driver (rider) of e-bike applies acceleration and brake pedal (lever) commands to minimize the difference of driving cycle and actual speeds of e-bike. The e-bike propulsion system is an electro motor (Electric Propulsion System), which is controlled by a motor controller. The electric energy of the electro motor is provided by the HESS. The brake controller block models the behavior of the mechanical brake of e-bike. The mechanical brake torque is the difference of driver negative torque demand and available regenerative torque of electro motor.

To analyse and compare a designed e-bike powertrain, its operating conditions are required for analysis and evaluation. A European (Portuguese standard NP EN 1986-1) driving cycle [3] has been chosen in this paper (.

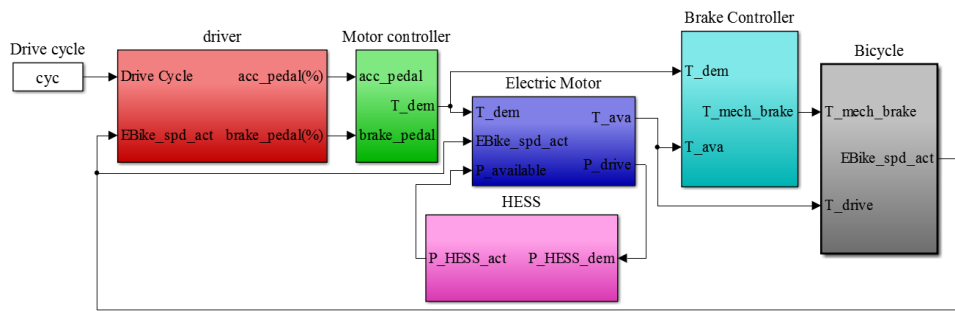

Fig1. E-bike powertrain model in MATLAB/Simulink

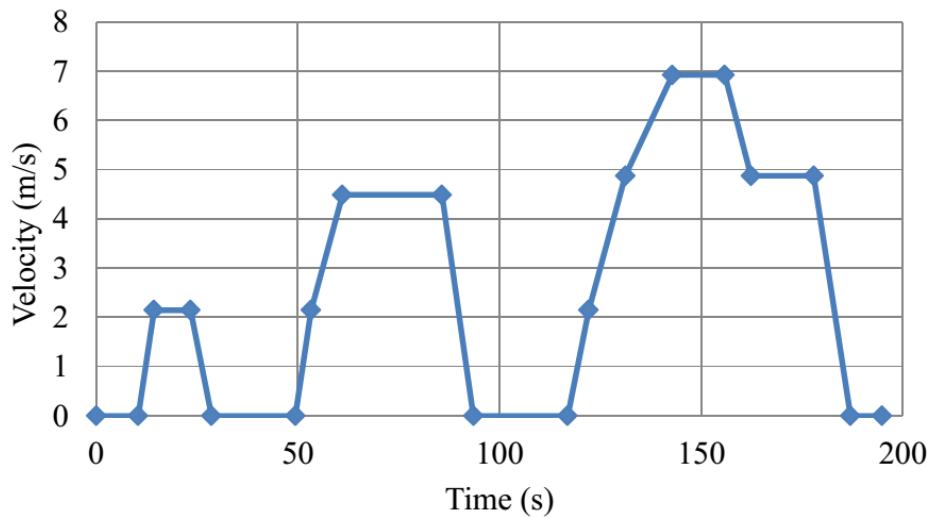

Fig2. Portuguese standard NP EN 1986-1 driving cycle for bicycle [3]

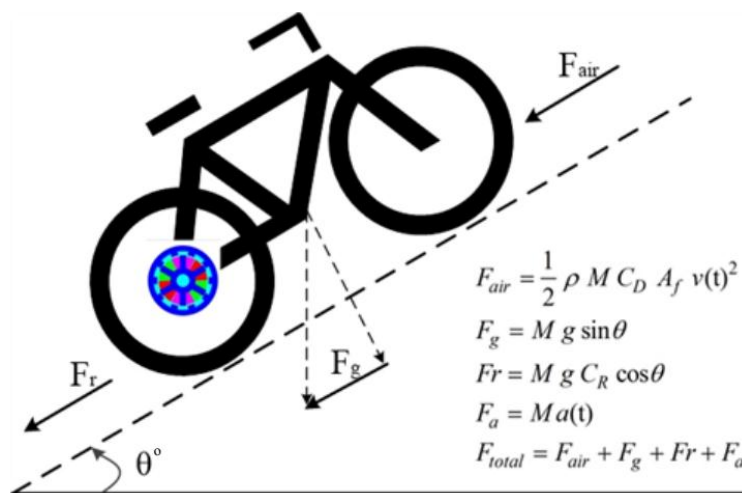

Fig3. Resistance Loads and Traction Force Applied to the E-bike [3]

3. E-bike powertrain design

The resistance loads and traction force applied to the e-bike are shown in the specifications of the e-bike are listed in Table 1 and the mechanical system parameters are presented in Table 2.

The mass factor is usually used for considering the equivalent mass increase due to the angular moments of the rotating components [6]. The mass factor can be written as:

$$\delta = 1 + \frac{J_w}{M \times R^2} + \frac{J_m I_{gear}^2}{M \times R^2} \tag{1}$$

In the equations of, the effective mass ($M \times \delta$) is used instead of the mass (M). The mass factor of the e-bike is 2.91 %.

The electro motor of this e-bike is designed by Lin et.al. at 2013 [1]. The specifications of the electro motor are listed in Table 3.

Table 1: E-bike specifications [5]

Items	Parameters	Values	Units
Mass of E-bike and Cyclist	M	100	kg
Acceleration due to gravity	g	9.81	m/s ²
Density of air	ρ	1.23	kg/m ³
Air resistance coefficient	C_D	0.5	-
Head Frontal Area (Cyclist)	A_f	0.5	m ²
Tire friction coefficient	C_r	0.004	-
Gradient of the road	θ	0	deg.

Table 2: Mechanical system parameters [1]

Items	Parameters	Values	Units
Frontal/rear radius	R	0.33	m
Moment of inertia of the rear wheel	J_w	0.0885	kg.m ²
Moment of inertia of the motor	J_m	0.0254	kg.m ²
Reduction gear ratio	I_{gear}	3	-
Motor efficiency	η_m	0.9	per unit
Chain efficiency	η_c	1	per unit
Gear efficiency	η_g	1	per unit

Table 3: Electro motor specification [1]

Items	Values	Units
Mechanical power output	500	W
Max speed	500	rpm
Max torque	9.5	N.m
Battery voltage	48	v
Max ampere	35	A

Table 4: Mechanical system parameters [7]

Items	Lead acid	NiMH	Li-ion
Mass-Energy density (Wh/kg)	20-30	50-60	100+
Stability	Stable	Stable	Supersaturating cause explosion
Memory effect	Y	Y	N
Cost	Low	More expensive than Li-ion	Capital cost about 3 times of Lead acid
Environmental concern	Lead pollution	Mild pollution	Lithium pollution

4. Energy storage optimal sizing

The common energy storage of e-bike is battery. The battery technology is the one that has slowed down the e-bike development. However, with new development, there become very opportunities for e-bike, on cost, reliability, safety and lifetime. There are kinds of electro-chemical battery accessible for the e-bike market, such as lead acid, nickel metal-hydrate (NiMH) and lithium-ion (Li-ion), etc. The comparison of these technologies is made in Table 4.

In this e-bike, a lead acid battery is used as the energy storage, because of its good cost and performance. Featuring rugged construction and packed tightly with pure lead plates, the AGM design ODYSSEY battery protects against the shock and vibration that can quickly destroy other batteries. And the pure lead plates mean more power—twice the overall power and three times the life of conventional batteries—up to 400 cycles at 80% depth of discharge, Table 5).

In Fig5 and Fig6, the open circuit and internal resistance of battery is showed, respectively. These figures are experimentally determined by Bazargan [9]. As seen in Fig5, the relation between OCV and SoC is very close as linear. Furthermore, the internal resistance of battery can be assumed constant (0.1 Ω), when the SoC is over than 20 %.

The life capacity is defined as the amount of charge that a battery can provide before its capacity loss reaches 20% [2]. The life capacity (LC) of the e-bike battery is:

$$LC = Ah \times 0.8 \times 400 \quad (2)$$

The driving cycle capacity loss ($Q_{loss-DC}$) is [2]:

$$Q_{loss-DC} = \frac{\int I dt}{LC} \quad (3)$$

The 10-years capacity loss ($Q_{loss-10y}$) is shown in Equation (4). In this equation the driving cycle capacity loss is divided by the driving cycle duration (t_{DC}) and is multiplied by 3600 (converting second to hour), 2 (a day working hours), 250 (a year working days) and 10, for 10-years capacity loss calculation. The duration of 10-years is chosen as a normal lifespan of an e-bike.

$$Q_{loss-10y} = \frac{Q_{loss-DC}}{t_{DC}} \times 3600 \times 2 \times 250 \times 10 \quad (4)$$

Values less than one for $Q_{loss-10y}$ mean that the battery does not need to be replaced during 10-years of working in a specific driving cycle. If $Q_{loss-10y}$ rounds toward positive infinity (“ceil” function), each ceil ($Q_{loss-10y}$) greater than one shows the number of battery replacements during 10-years.

The cost of e-bike battery during 10-years ($Cost_{bat-10y}$) is determined by Equation (5). In this equation, the number of battery replacements needed (ceil ($Q_{loss-10y}$)) is multiplied by 4 (number of batteries in series connection for providing 48 v) and $\frac{Ah}{18} \times 128\$$ (the cost of PC625 Odyssey battery [8]).

$$Cost_{bat-10y} = \text{ceil} (Q_{loss-10y}) \times 4 \times \frac{Ah}{18} \times 128\$ \quad (5)$$

In, the number of battery replacements and the cost of battery in 10-years life of e-bike are shown, respectively. As seen in the number of battery replacements reduces as the Ah of battery increases. This reduction is higher in small Ah than large Ah. Respect to the minimum cost of battery are occurred in about 4 Ah and 7 Ah, between 400 \$ to 450 \$.



Fig4. PC625 Odyssey Lead-acid battery (18Ah) [8]

Table 5: PC625 Odyssey Lead-acid battery (18Ah) [8]

Items	Values	Units
Pulse (5-second) Hot Cranking Amps (PHCA)	530	A
Cold Cranking Amps (CCA)	200	A
20Hr Nominal Capacity (Ah)	18	Ah
Reserve Capacity Minutes	27	min.
Metric Dimensions L x W x H	170.2x99.1x175	mm
Weight	6	Kg

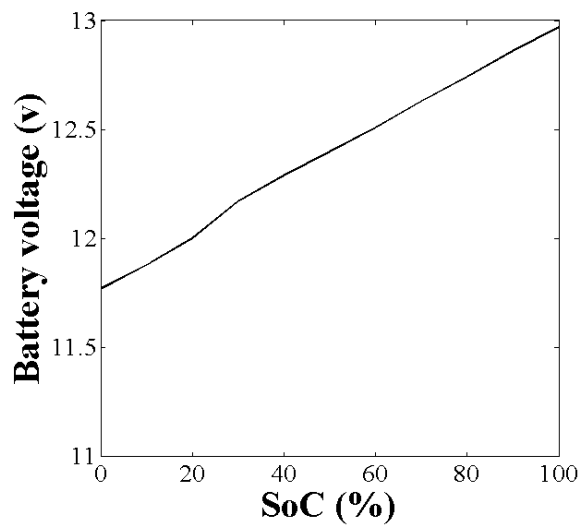

Fig5.: Open circuit voltage of battery [9]

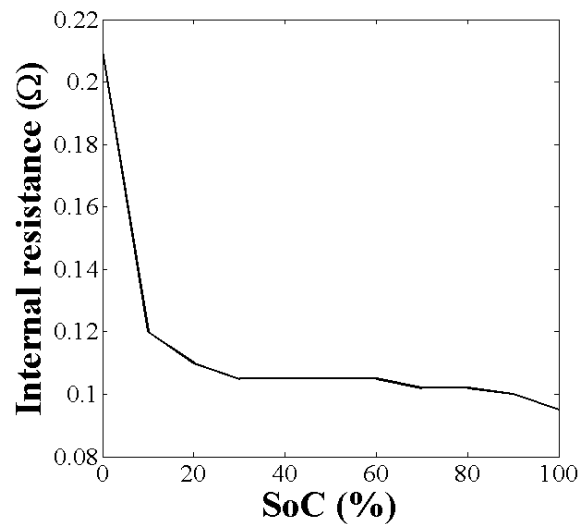

Fig6.: Internal resistance of battery [9]

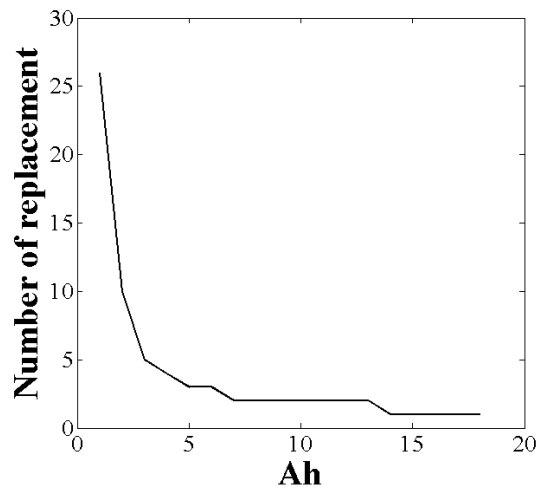

Fig7. Number of battery replacement in 10-years

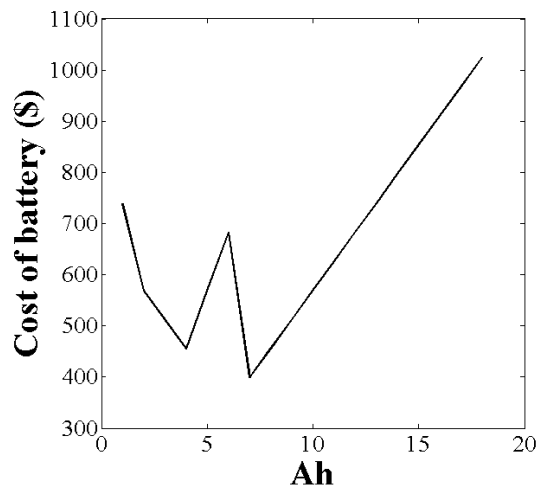

Fig8. Number of battery replacement in 10-years

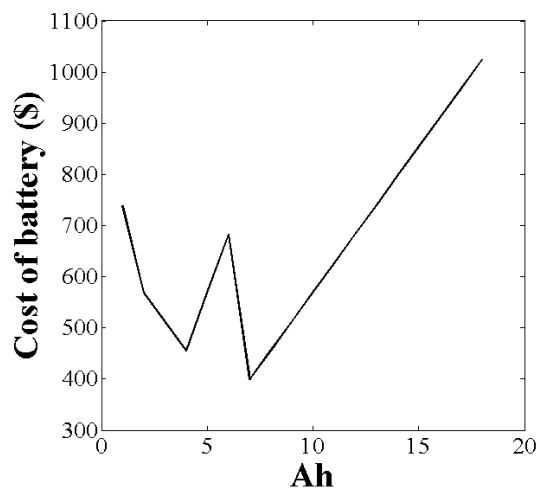

Fig9. Cost of battery in 10-years

5. Hybrid energy storage design

The Hybrid Energy Storage System (HESS) is consisted of battery, UC and DC/DC converter. In this paper, the UC of Maxwell technologies®, Boostcap® type, BMOD0083 P048 B01 model is used and Table 6. In addition, the power of DC/DC converter is assumed to be 500 W (equal to electro motor power).

The cost of e-bike HESS during 10-years ($Cost_{HESS-10y}$) is determined by Equation (6). In addition to Equation (5), the cost of DC/DC converter ($0.5 \times 50\$$, means 0.5 kW and for each kW, 50 \$ [2]) and the cost of UC (for each kWh equal to 15000 \$ [2]) are augmented.

$$Cost_{HESS-10y} = \text{ceil} (Q_{loss-10y}) \times \frac{4 \times Ah \times 128\$}{18} + 0.5 \times 50\$ + \frac{F_{UC} \times 0.027}{80} \times 15000\$ \quad (6)$$

As seen in Equation (6), the DC/DC converter and UC replacement is not needed in long time operation, in contrast to battery.

In Fig12, the number of HESS battery replacement and cost of HESS for 4 Ah battery and different UC capacities in 10-years life of e-bike are

shown, respectively. As seen in, the number of battery replacements is reduced as the UC capacity increases, significantly. The number of replacements is 4 with no UC, is 2 for 2.5 F UC and is 1 for bigger UCs. Respect to Fig12, the minimum cost of HESS is occurred in about 2.5 F UC. This figure shows HESS with 2.5 F UC cost is about 300 \$, in contrast to 450 \$ without UC.

In Fig13 and Fig14, contours of number of battery replacement and HESS cost for different battery and UC capacities are shown, respectively. As seen in Fig13, increasing in battery or UC capacity causes reduction of battery replacements needed. Fig14 shows that the highest cost of HESS are occurred in small and large battery capacities without UC. The best zone of HESS sizing in this figure is small battery capacity with over than 5 F UC.

The strong non-linearity of the HESS cost (Fig14) lead to use the heuristic optimization methods. The Genetic Algorithm (GA) optimization method as a well-known and powerful method is selected in this paper. The parameters of GA are listed in Table 7.

The final result of HESS cost optimal sizing is listed in Table 8 and is compared with battery optimal sizing. As seen in this table, the cost and weight of HESS is clearly better than battery ESS.



Fig10. BMOD0083 P048 B01 ultra-capacitor [10]

Table 6: BMOD0083 P048 B01 ultra-capacitor specifications [10]

Items	Values	Units
Capacitance	80	F
Peak current	2010	A
Power (1 s)	97.7	kW
Maximum continuous current	115	A
Maximum continuous power	5.6	kW
Nominal voltage	48.6	v
Energy	27	Wh
Weight	11	Kg

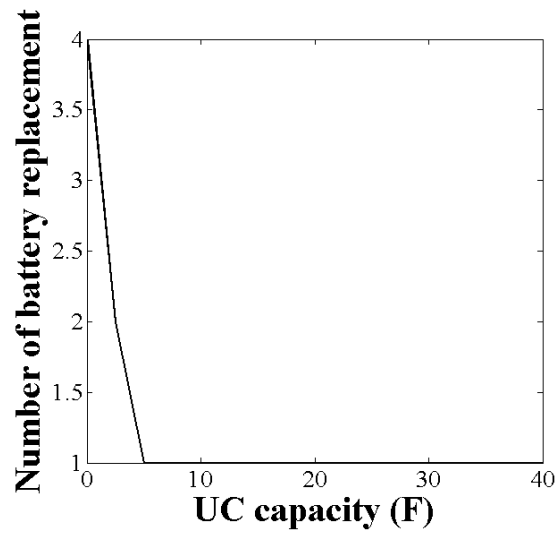

Fig11. Number of HESS battery replacement for 4 Ah battery and different UC capacities in 10-years

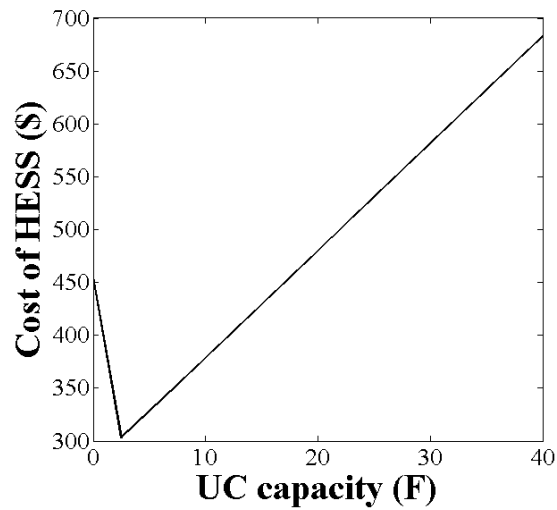

Fig12. : Cost of HESS for 4 Ah battery and different UC capacities in 10-years

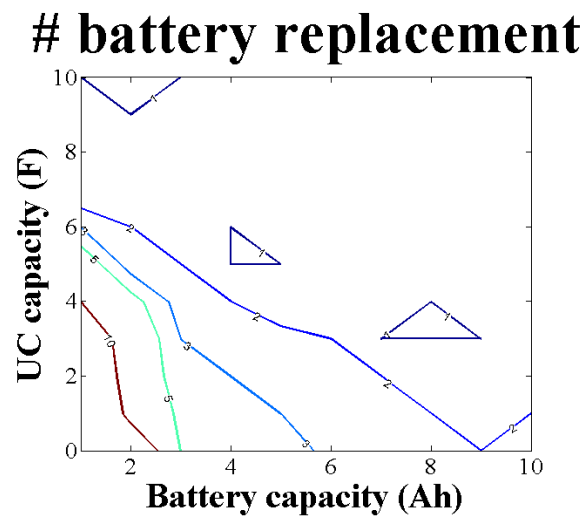

Fig13. : Contour of number of battery replacement for different battery and UC capacities

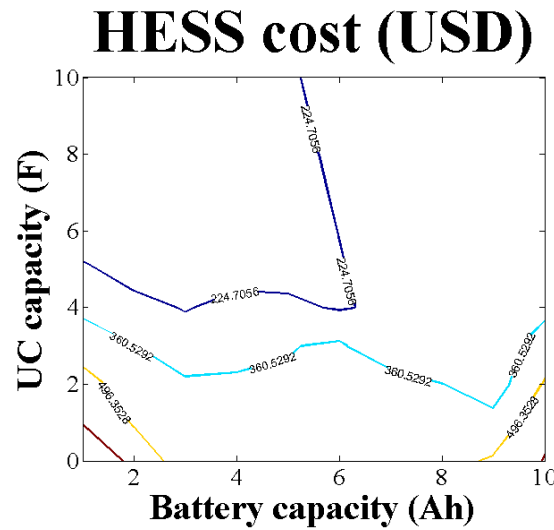

Fig14. : Contour of HESS cost for different battery and UC capacities

Table 7: Parameters of genetic algorithm

Parameter	Description
Variables	Ah_bat, F_UC
Range of variables	[1,10], [0:10]
Type of variables	integer, integer
Fitness function	HESS cost
CreationFcn, CrossoverFcn, Crossover Fraction, Elite Count, MutationFcn	MATLAB default

Table 8: Optimal sizing of battery and HESS comparison

Item	Units	Battery ESS	HESS
Battery capacity	Ah	7	1
UC capacity	F	0	7
# battery replacement	-	2	1
ESS cost	USD	398.2	88.9
Weight	kg	2.33	1.30

6. Conclusion

A procedure of energy storage optimal sizing respect to the initial and replacements cost of battery during lifespan of the electric system is developed in this paper. As a case study, the HESS of an e-bike is designed optimally using GA method. The results showed that the highest cost of HESS are occurred in small and large battery capacities without UC. The best zone of HESS sizing is small battery capacity with over than 5 Farad UC. The cost and weight of optimal designed HESS is clearly better than optimal designed battery ESS.

The procedure of this paper can be used for optimal ESS sizing of other electric systems. Furthermore, the fitness function of optimal ESS sizing can be improved by adding the effect of ESS sizing on the operating distance of electric vehicle. This work can be done in future researches.

Acknowledgement

This work was support by Automotive Engineering Research Center (AERC) of Iran University of Science and Technology (IUST) and Vehicle, Fuel and Environment Research Institute (VFERI) of University of Tehran (UT).

References

- [1]. J. Lin, N. Schofield, and A. Emadi, "External-rotor 6 #x2013;10 switched reluctance motor for an electric bicycle," in *Industrial Electronics Society, IECON 2013 - 39th Annual Conference of the IEEE*, 2013, pp. 2839–2844.
- [2]. M. Masih-Tehrani, M. R. Ha'iri-Yazdi, V. Esfahanian, and A. Safaei, "Optimum sizing and optimum energy management of a hybrid energy storage system for lithium battery life improvement," *J. Power Sources*, vol. 244, pp. 2–10, 2013.
- [3]. D. M. Sousa, P. J. Costa Branco, and J. A. Dente, "Electric bicycle using batteries and supercapacitors," in *2007 European Conference on Power Electronics and Applications, EPE*, 2007.
- [4]. A. L. Allègre, A. Bouscayro, and R. Trigui, "Influence of control strategies on battery/supercapacitor hybrid Energy Storage Systems for traction applications." 2009.
- [5]. E. A. Lomonova, A. J. A. Vandenput, J. Rubacek, B. d'Herripon, and G. Roovers, "Development of an improved electrically assisted bicycle," *Conf. Rec. 2002 IEEE Ind. Appl. Conf. 37th IAS Annu. Meet. (Cat. No.02CH37344)*, vol. 1, 2002.
- [6]. M. Ehsani, Y. Gao, and A. Emadi, *Modern Electric, Hybrid Electric, and Fuel Cell Vehicles: Fundamentals, Theory and Design*. CRC press, 2009.
- [7]. What is the perfect battery?," <http://www.buchmann.ca/article4-page1.asp>, 2013.
- [8]. PC625 Odyssey Lead-acid battery (18Ah)." <http://shop.odysseybattery.com/p/pc625-p>.
- [9]. D. Bazargan, *Battery Storage Systems for Wind Farms: A Real-Time Hardware-in-loop Simulation Study*. LAP Lambert Academic Publishing, 2013.
- [10]. "Maxwell ultracapacitor, BMOD0083 P048 B01." <http://www.maxwell.com/products/ultracpacitors/products/48v-modules>.