

Enhancement of vehicle stability by adaptive fuzzy and active geometry suspension system

M. Baghaeian^{1,*} and A.A. Akbari²

1. Ph.D. student, 2. Assistant professor, Department of Mechanical Engineering, Ferdowsi University of Mashhad, Iran

mansour.baghaeian@yahoo.com

Abstract

In this paper, the enhancement of vehicle stability and handling is investigated by control of the active geometry suspension system (AGS). This system could be changed through control of suspension mounting point's position in the perpendicular direction to wishbone therefore the dynamic is alternative and characteristics need to change. For this purpose, suitable controller needs to change mounting point's position in limit area. Adaptive fuzzy control able to adjust stability and handling characteristics in all conditions. Also, simple controller such as proportional-integral-derivative (PID) versus adaptive fuzzy have been used that submit intelligent controllers. The three of freedom model (3DOF) in vehicle handling is validated with MATLAB and CarSim software. The results show that the steady state response of the adaptive fuzzy controller has been closed to desired yaw and roll angle has been enhanced about %20. In cases of lateral velocity and side slip angle have the same condition that it shows the stability has been improved. The control effort of PID needs to change very high that this response is not good physically, while control effort in adaptive fuzzy is less than 50 mm.

Keywords: Active geometry suspension system, stability, handling, adaptive fuzzy control

1. Introduction

In recent years, more acts for the enhancement of vehicle's stability and handling in cornering have been doing that a lot of those are with longitudinal dynamic and breaking and acceleration force such as electronic stability program (ESP) and traction control system (TCS). In the past two decades, the active suspension system has not been used due to high cost and energy consumption. AGS is kind of active suspension systems that don't have all of the above problems [1-6].

Prototype of active suspension system for a car was built by Westinghouse Corporation in 1961. For many years following, there was spasmodic activity in the field, from the mid-1980s to 1990s, almost to the present time, active car suspensions have been a very hot research topic and a large number of papers on many aspects of the subject have been published in a variety of journals. The Velocette Thruxton motorcycle has been first active geometry suspension that the ratio of wheel movement to spring movement could be changed manually [1].

Sharp et al. [3] changed the end position of spring and damper to the wishbone, actively with electrical actuators by PD, optimal-PD and Neuro-controllers. They could be reduced body roll and roll center height alteration. Lee et al. [4] increased stability and ride comfort by AGS. Lee et al. [5] Could to achieve a good transient response in medium and high speeds with toe control, road test and experimental test, also they enhanced vehicle stability and handling. Evers et al. [6] presented a new AGS model of actuator force that was gotten from a Delft model that they got the actuator's force and frequency for steady state response. Goodarzi et al. [7] presented multi linked suspension's mounting point variation relate to the roll center height and toe angle directly with ADAMS software. Also they showed vehicle stability and handling are increased by PI-Fuzzy. In the past two decades, many patents have been made that some of them were not good products [8-12].

One of the methods which can handle uncertainty is adaptive control. In adaptive control, adaptation law adjusts the parameters of the controller against system uncertainties and disturbances. One of the methods has been used in many of the papers recently is fuzzy logic systems [13-16]. Fuzzy logic provides

an important tool utilize human expert knowledge in complement to mathematical knowledge.

A hybrid combination of adaptive control and fuzzy logic is an attractive and powerful approach for designing robust control systems with high degrees of nonlinearities and uncertainties. If human information is about nonlinear dynamic systems that is a direct adaptive fuzzy and if human information is about control of a system that is indirect adaptive fuzzy. There are many papers in the field of adaptive fuzzy controller. For example Wang in 1993 [13] has designed a direct adaptive fuzzy and he has gotten adaptive rules with lyapunov theory. Also Wang at 1996 [14] kind of general solution for designing of stable adaptive fuzzy controller with lyapunov theory presented and he used the controller in inverted pendulum of two degrees of freedoms. After that Tang [15] designed an adaptive fuzzy controller base of input and output of the nonlinear system model. Shahnazi and Akbarzade in 2008 have been introduced indirect adaptive fuzzy of the PI controller versus routine adaptive fuzzy controller that the speed convergence in near of equilibrium point [20]. Also Lee et al. in 2012 an adaptive fuzzy presented for control of random system [16].

In this paper, changing of suspension's mounting point has been studied with adaptive fuzzy that characteristics of stability such as yaw rate and roll angle have been improved.

2. Active geometry suspension system

The suspension system has three important operate. Lateral, longitudinal and vertical

performances are important working area in suspension. Active suspension improves performance in all conditions and AGS has a good performance in lateral dynamics especially in stability.

Fig. (1) Illustrates double wishbone suspension that it is independent suspension. Roll center height and lower wishbone angle are expressed by h_{Ro} and β .

Roll center height is related to geometric parameters by Eq. (1), (2) and (3).

$$h_{Ro} = b_f/2 \frac{p}{k \cos \beta + d \tan \sigma + r_\sigma} \tag{1}$$

$$p = k \sin \beta + d \tag{2}$$

$$k = c \frac{\sin(90+\sigma-\alpha)}{\sin(\alpha+\beta)} \tag{3}$$

Changing of suspension lower link's mounting point is caused the roll center height and toe angle are varied.

In Fig. 2 has been shown changing of suspension lower link's mounting point depend to the roll center height alteration by Eq. (1). Also linearity can be expressed by Fig. 2 as:

$$h_{Ro} = c \Delta_x \tag{4}$$

Also, changing of suspension lower link's mounting point depend to the toe angle alteration linearly [7] as:

$$\Delta k_{sr} = c \Delta_x \tag{5}$$

Eq. (4) and (5) can be used in handling equations of the 3DOF model with AGS that Δ_x Can be seen in the steady state equations and C1, C2 can be calculated by figures that are produced [7].

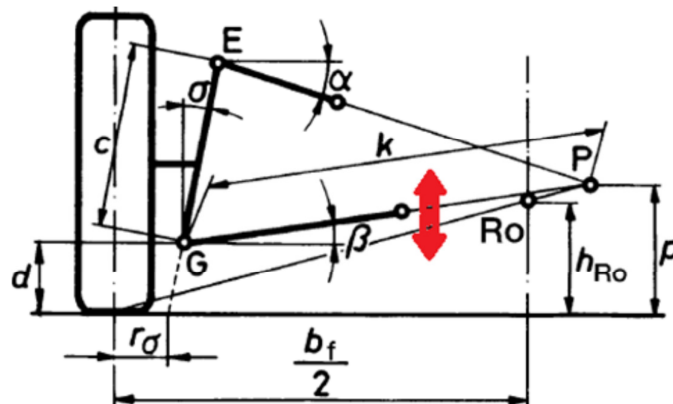

Fig1. Double wishbone suspension schematic [17]

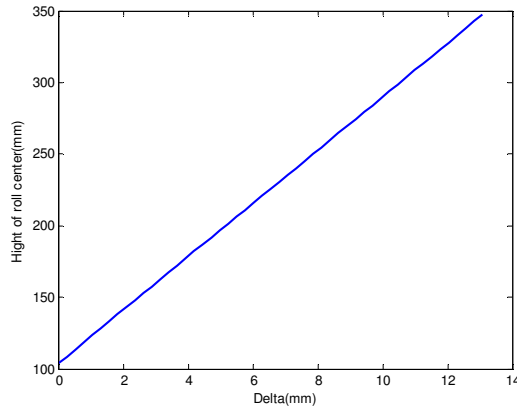

Fig2. Changing of suspension lower link's mounting point depend to the toe angle alteration

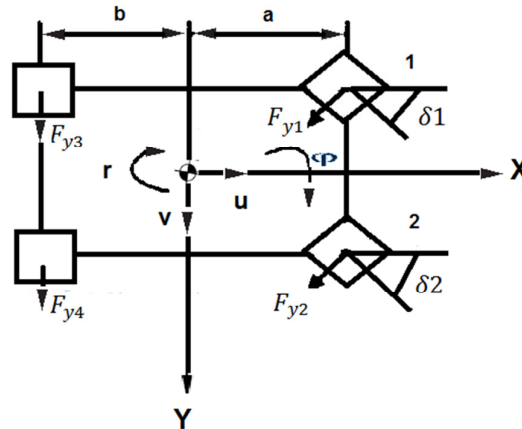

Fig3. 3DOF handling model

3. Dynamic modeling and stability analysis

3DOF model is used in order to analysis of vehicle's stability and handling that lateral velocity, roll angle and yaw rate are degrees of freedom.

Schematic of 3DOF model has been shown in Fig. 3 that equation can be written in X, Y and Z axes motions respectively:

$$F_{y1} \cos \delta 1 + F_{y3} + F_{y2} \cos \delta 2 + F_{y4} = m(\dot{v} + ur) + m_s \dot{h} \tag{6}$$

$$I_{zz} \dot{r} = a(F_{y1} \cos \delta 1 + F_{y2} \cos \delta 2) - b(F_{y3} + F_{y4}) \tag{7}$$

$$I_{xx} \ddot{\phi} + c_t \dot{\phi} + (k_t - m_s g \dot{h}) \phi = -(\dot{v} + ur) m_s \dot{h} \tag{8}$$

Where \dot{h} is the initial distance between the roll axis and the center of gravity of the sprung mass, m_s is sprung mass, k_t and c_t are total stiffness and

damping of the suspension system. Also δ is small therefor $\cos(\delta)$ can be used equal one.

The tire model in this study is expressed by the well-known linear equation given below

$$F_y = C_{\alpha} \cdot \alpha \tag{9}$$

The expressions for the slip angle of each wheel can be written as a function of the given variables:

$$\begin{aligned} \alpha_1 &= \delta_{T1} - \left(\frac{v+ar}{u}\right) \\ \alpha_2 &= \delta_{T2} - \left(\frac{v+ar}{u}\right) \\ \alpha_3 &= \delta_{T3} + \left(\frac{br-v}{u}\right) \\ \alpha_4 &= \delta_{T4} + \left(\frac{br-v}{u}\right) \end{aligned} \tag{10}$$

Where δT is the total steering angle which is the sum of the driver steering angle (δ) and the additional roll steer term. The roll steer term is produced by the roll motion of the vehicle

$$\ddot{\delta}_{Ti} = \begin{cases} \delta_i + K_{Sr}\varphi & i = 1,2 \\ K_{Sr}\varphi & i = 3,4 \end{cases} \quad (11)$$

The state space equation can be expressed by using Eq. (4-11) [7] as:

$$\begin{bmatrix} m & 0 & 0 & m_s h_0 - m_s C_2 \Delta x \\ 0 & I_{zz} & 0 & 0 \\ m_s h_0 - m_s C_2 \Delta x & 0 & 0 & I_x \\ 0 & 0 & 1 & 0 \end{bmatrix} \begin{bmatrix} \dot{X}_1 \\ \dot{X}_2 \\ \dot{X}_3 \\ \dot{X}_4 \end{bmatrix} + \begin{bmatrix} A_{11} & A_{12} & A_{13} - c_{\alpha 3} C_1 \Delta x & 0 \\ A_{21} & A_{22} & A_{23} + b c_{\alpha 3} C_1 \Delta x & 0 \\ 0 & A_{32} - m_s u C_2 \Delta x & A_{33} + m_s g C_2 \Delta x & A_{34} \\ 0 & 0 & 0 & -1 \end{bmatrix} \begin{bmatrix} X_1 \\ X_2 \\ X_3 \\ X_4 \end{bmatrix} + \begin{bmatrix} B_1 \\ B_2 \\ 0 \\ 0 \end{bmatrix} \delta = 0 \quad (12)$$

Where :

$$\begin{aligned} A_{11} &= \frac{c_{\alpha 1} + c_{\alpha 2} + c_{\alpha 3} + c_{\alpha 4}}{u} \\ A_{21} &= \frac{a(c_{\alpha 1} + c_{\alpha 2}) - b(c_{\alpha 3} + c_{\alpha 4})}{u} \\ A_{22} &= \frac{a^2(c_{\alpha 1} + c_{\alpha 2}) + b^2(c_{\alpha 3} + c_{\alpha 4})}{u} \\ A_{12} &= m u - \frac{(c_{\alpha 3} + c_{\alpha 4})b - (c_{\alpha 1} + c_{\alpha 2})a}{u} \\ A_{13} &= -c_{\alpha 1} K_{Sr1} - c_{\alpha 2} K_{Sr2} - c_{\alpha 3} K_{Sr3} + -c_{\alpha 4} K_{Sr4} \\ A_{23} &= -a(c_{\alpha 1} K_{Sr1} + c_{\alpha 2} K_{Sr2}) + b(c_{\alpha 3} K_{Sr3} + c_{\alpha 4} K_{Sr4}) \\ A_{32} &= m_s h_0 u \\ A_{33} &= K_t - m_s g h_0 \\ A_{34} &= c_t \end{aligned} \quad (13)$$

4. Validation

In order to validate a 3DOF model has been used full vehicle model in CarSim software that it is power full software in vehicle dynamic and 2DOF handling model with the sport utility vehicle's (SUV) data. Vehicle data have been expressed in a table (1). The CarSim software has many options in vehicle dynamic that some of them have been illustrated in Fig. 4. Inputs are step, lane change (LC) and double lane change (DLC) that for example in Fig. 5 has been shown DLC input. All inputs of the model have a good response versus 2DOF and Carsim model. While in Fig. 6- 8 are shown 3DOF model has a good condition of lateral speed, body side slip angle and yaw rate. Also in Fig. 9 is shown yaw rate response is near the response of CarSim model

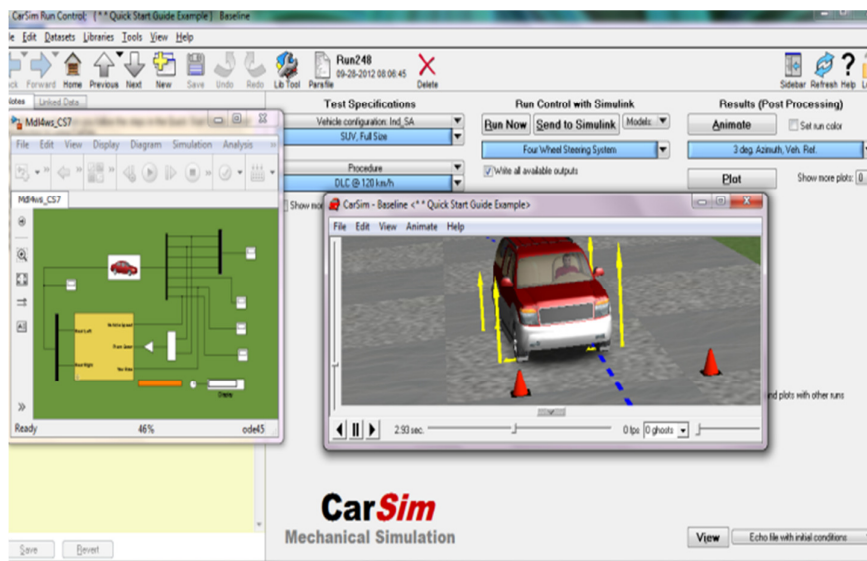
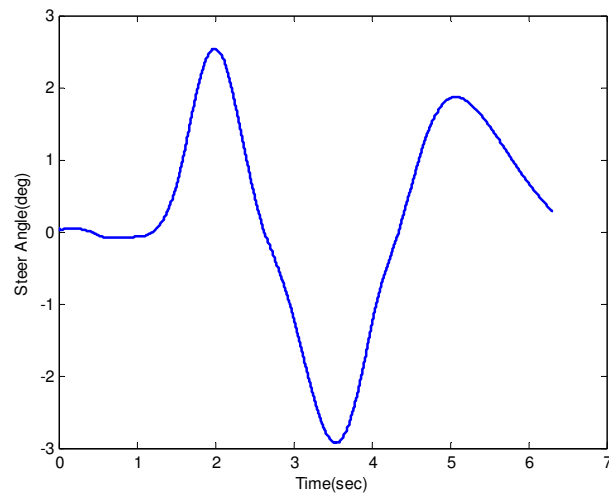
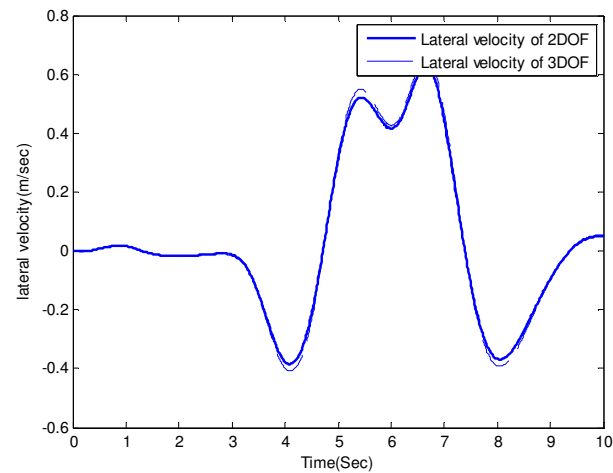

Fig4. Vehicle dynamic softwar

Table 1. Vehicle data

m	1987	Kg	Ct	3495.7	Ns/m
mus	324.935	kg	h	0.54	m
L	2.5780	m	Ix	657.2714	Kgm ²
a	1.1473	m	Iz	4510.3	Kgm ²
T	1.4	m	KR	0.4
Kt	56957	N/m	ca	30000	N/rad
ksr	0.02	kus	0.01

**Fig5.** Steering wheel angle in DLC maneuver**Fig6.** Lateral velocity response for DLC manoeuvre

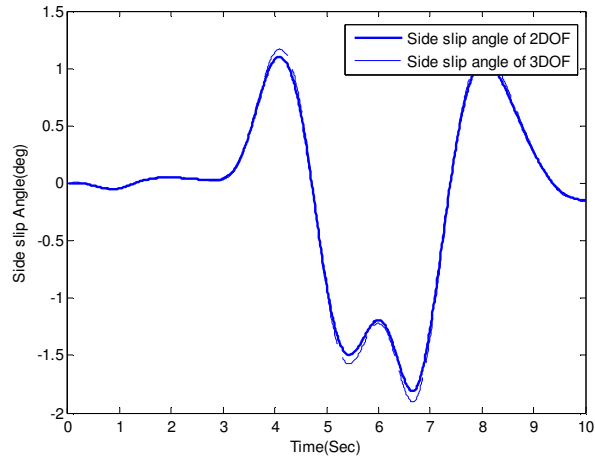

Fig7. Side slip angle response for DLC maneuver

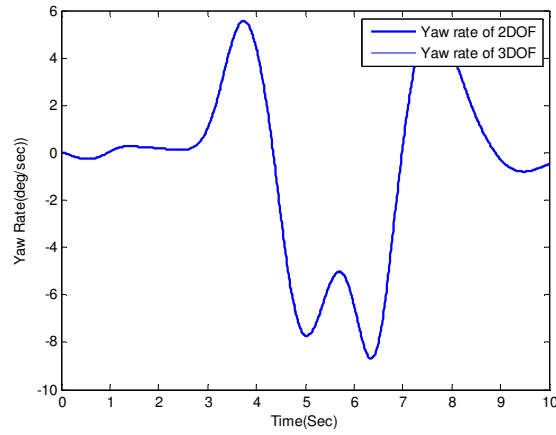

Fig8. Yaw rate response for DLC maneuver

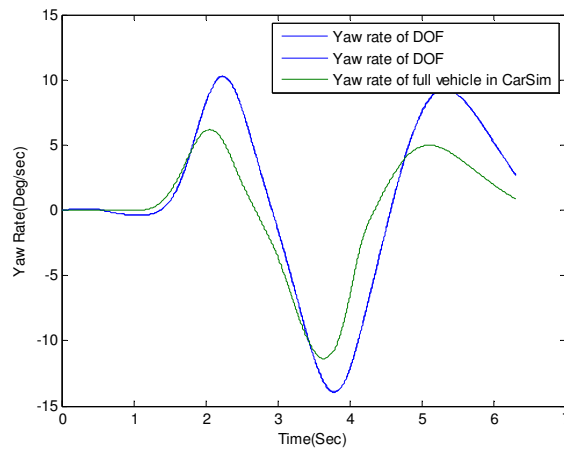

Fig9. Yaw rate response for DLC maneuver

5. The Proposed Controller

5.1 PID Controller

At first, The responses were processed by the industrial controller such as PID. The controller characteristics were optimized with a Generic algorithm (GA) method for example DLC input parameter has been gotten 1.31, .07 and .02 for P, I and D.

5.2 Adaptive fuzzy controller

This controller able to handle uncertainty parameters and it has adaptive rule that can adjust controller system parameters online [19]. Fig.10 illustrates an adaptive controller structure of nonlinear system as:

$$x^{(n)} = f(x, t) + g(x, t)u + d(t) \tag{14}$$

In this equation $f(x, t)$, $g(x, t)$ is unknown bounded nonlinear functions. For controllability of the system $g(x, t)$ should not be zero. $x = [x, \dot{x}, \dots, x^{(n-1)}]^T$ is state vector of the system which it is assumed to be available for measurement. In the above equation $d(t)$ is the unknown external disturbance with limited bounded.

The control can be driven by [20]:

$$u^* = \frac{1}{g(x)} [-f(x) + y_m^{(x)} + K^T E] \tag{15}$$

In above equation $y_m^{(x)}$ is reference vector and E is tracing vector.

Where

$$E = y_m - x = [e, \dot{e}, \dots, e^{(n-1)}]^T \tag{16}$$

In Eq. (15) K must be the coefficients of the Hurwitz polynomial.

While the parameters of nonlinear system such as $f(x)$ and $g(x)$ are unknown, we can't use the above controller, but we can use fuzzy systems for obtaining unknown dynamics. Generally, a fuzzy system consists of fuzzifier; fuzzy rule base; fuzzy inference engine and defuzzifier. The fuzzy rule base consists of rules collection as *If* and *then* and they can be shown by:

$$R^l : \text{IF } x_1 \text{ is } F_1^l \text{ and } \dots \text{ and } x_n \text{ is } F_n^l \text{ Then } y \text{ is } G^l \quad l = 1, \dots, M \tag{17}$$

Where $x = [x, \dot{x}, \dots, x^{(n-1)}]^T$ are input and y are the fuzzy output of the system. F_i^l, G^l are the antecedent and the consequent sets respectively. The output of fuzzy system will be as Eq. (17) with fuzzifier singleton, Mamdani-fuzzy inference engine and defuzzifier centroid.

$$y = \frac{\sum_{l=1}^M \bar{y}^l \prod_{i=1}^n \mu_{F_i^l}(x_i)}{\sum_{l=1}^M \prod_{i=1}^n \mu_{F_i^l}(x_i)} = \theta^T \xi(x) \tag{18}$$

$$\theta = [\bar{y}^1, \bar{y}^2, \dots, \bar{y}^M]$$

Where M is number of fuzzy rules, $\theta = [\bar{y}^1, \bar{y}^2, \dots, \bar{y}^M]^T$ is center of output membership function and $\xi(x) = [\xi_1(x), \xi_2(x), \dots, \xi_M(x)]$ is the fuzzy rule base and can be calculated by:

$$\xi_j(x) = \frac{\prod_{i=1}^n \mu_{F_i^j}(x_i)}{\sum_{l=1}^M \prod_{i=1}^n \mu_{F_i^l}(x_i)} \quad j = 1, \dots, M \tag{19}$$

In order to have a good performance, it's better using of adaptive rules for adjusting of membership function in consequent fuzzy rules. Generally adaptive control is divided to direct adaptive controller, indirect adaptive controller and combine an adaptive controller [20].

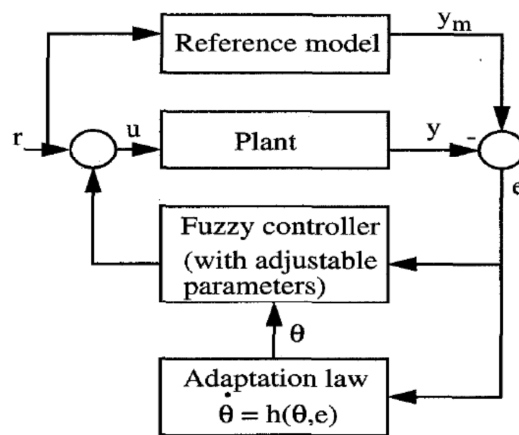

Fig10. Structure of the adaptive fuzzy controller [20]

In direct adaptive controller has been used in this research, nonlinear dynamics of the control system are trying to estimate with fuzzy function, this estimation has been adjusted with adaptive rule online and nonlinear system can be controlled. For example from below equations can be updated rules [20-21].

$$\begin{aligned} \dot{\theta}_f &= -\gamma_1 EPB\xi(x) & \tilde{f}(x|\theta_f) &= \theta_f^T \xi(x) \\ \dot{\theta}_g &= -\gamma_2 EPB\xi(x)u & \tilde{g}(x|\theta_g) &= \theta_g^T \xi(x) \end{aligned} \quad (20)$$

γ_1, γ_2 are positive parameter and P can be obtained from Lyapunov equation.

It is better, base of fuzzy control information made from the rule and membership function [22] that is a parabolic function [7]. The structure of Fig. 10 is used to control the system. As well as in Fig. 11 is illustrated, 3DOF handling model has been used and system input is steering wheel angle, system outputs are lateral velocity, yaw rate and body roll

angle. In order to enhance of vehicle stability, control inputs are error of the yaw rate and time derivative of the yaw rate and three membership functions can be used respectively by:

$$\begin{aligned} \mu_N(e) &= \frac{1}{1+\exp(8*(5e+5))} \\ \mu_Z(e) &= \exp(-40e^2) \\ \mu_P(e) &= \frac{1}{1+\exp(-8*(5e+5))} \\ \mu_N(\dot{e}) &= \frac{1}{1+\exp(8*(\dot{e}+1))} \\ \mu_Z(\dot{e}) &= \exp(-10\dot{e}^2) \\ \mu_P(\dot{e}) &= \frac{1}{1+\exp(-8*(\dot{e}+1))} \end{aligned} \quad (21)$$

Membership function shapes are illustrated in Fig. 12 and Fig. 13.

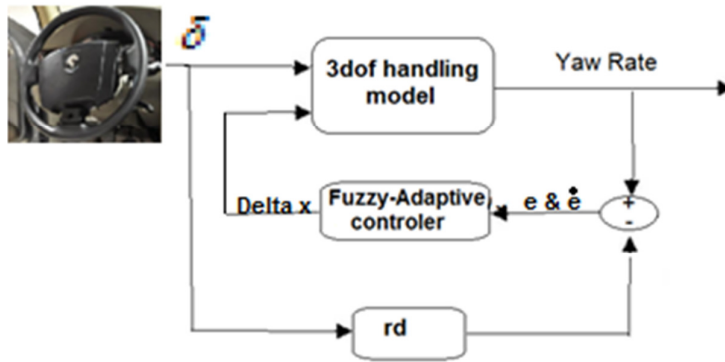

Fig11. Control structure of AGS

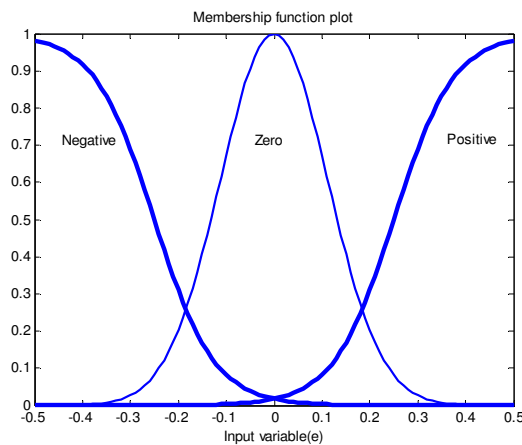

Fig12. Input membership function

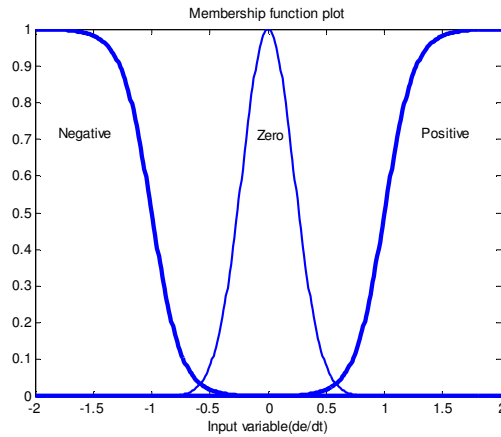

Fig13. Input membership function with time derivative of the error

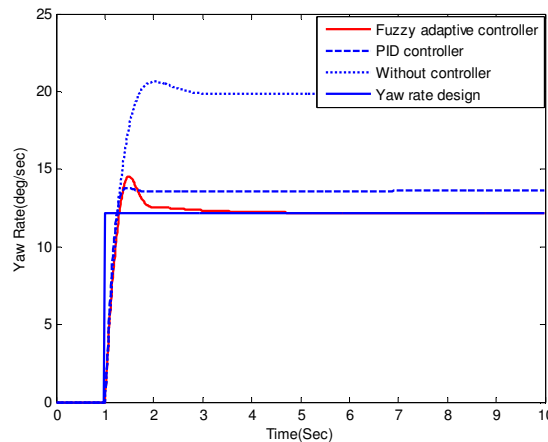

Fig14. Yaw rate response for step manoeuvre

The adaptive rules are used for adjusting of fuzzy consequent sets, fuzzy set is in [0,1] randomly.

Standard inputs have been used such as step, LC and DLC. Input domain is 4 degrees of the front wheel and longitudinal velocity is 20 m/s. r_d has been used respectively by:

$$r_d = \frac{\delta u}{L + K_{us} u^2} \tag{22}$$

Where δ is the input wheel angle, u is longitudinal velocity, K_{us} is the under steer gradient and L is wheel base.

6. Result

In Fig. (14-17) can be seen responses that stability characteristics have increased for step input. Fig. 14 shows to reduce yaw rate. Also the response of the adaptive fuzzy controller has been closed to r_d , roll

angle has been enhanced about %20. In cases of lateral velocity and side slip angle have the same condition that it shows the stability has improved. While in Fig. 19 is shown control effort of PID need to change very high that this response is not good physically. Responses of adaptive fuzzy controller versus PID have reduced about %10 while control effort in adaptive fuzzy is about 50 mm. AGS should be required to use an intelligent controller because the dynamic is alternative and characteristics need to change that the adaptive fuzzy controller can be a good choice.

Responses of LC input are shown in Fig. 20- 23 that PID controller has the good responses in the first half cycle but in the next half cycle does not have good performance. While adaptive fuzzy controller has been changed mounting point in cycle rightly.

Variation of changing mounting point in adaptive fuzzy is 150 mm less than PID and it is around 50mm.

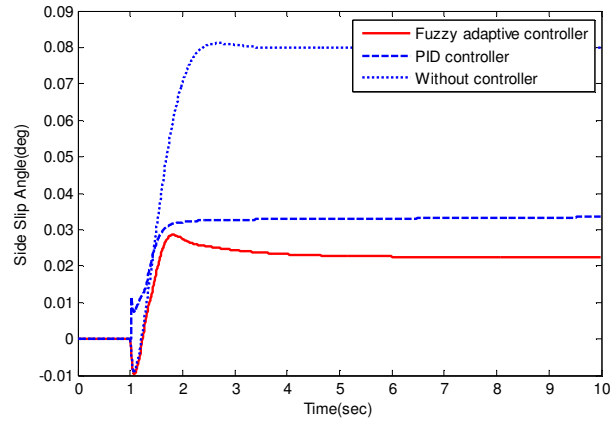

Fig15. Side slip angle response for step manoeuvre

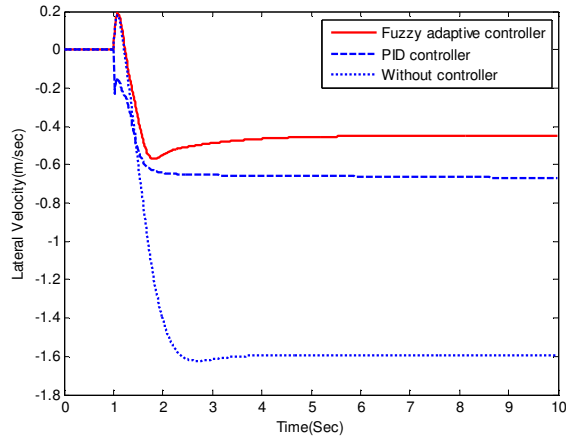

Fig16. Lateral velocity response for step maneuver

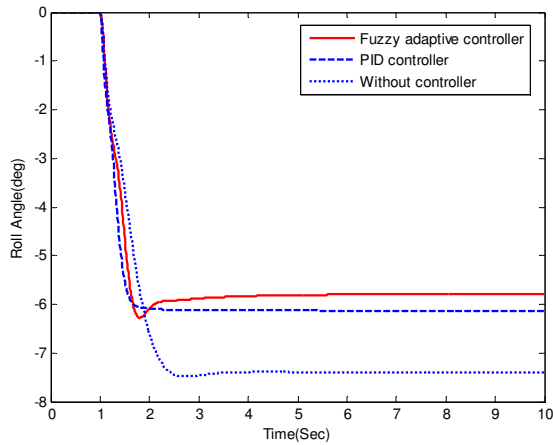

Fig17. Roll angle response for step manoeuvre

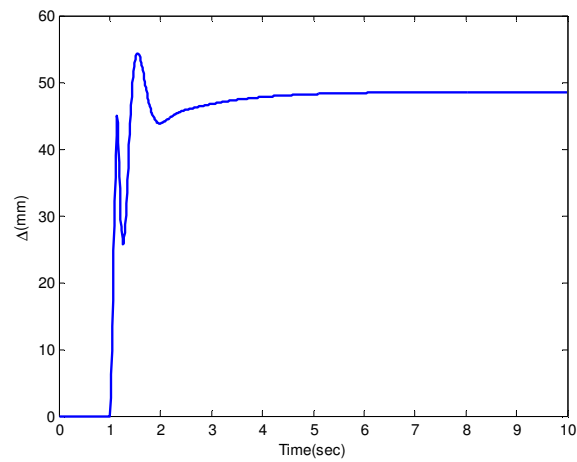

Fig18. Mounting point changing with the adaptive fuzzy controller

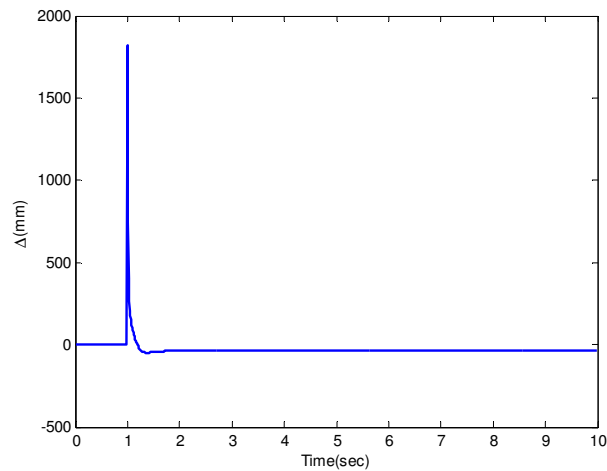

Fig19. Mounting point changing with the PID controller

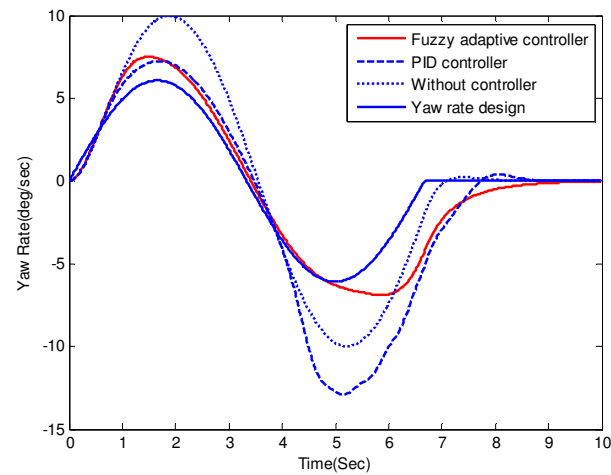

Fig20. Yaw rate response for LC maneuver

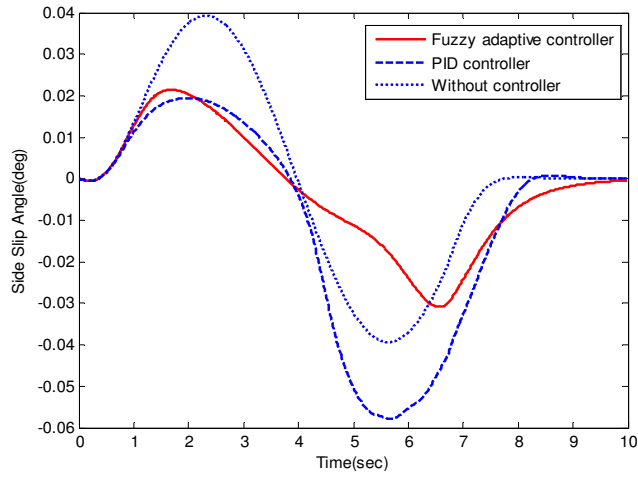

Fig21. Side slip angle response for LC maneuver

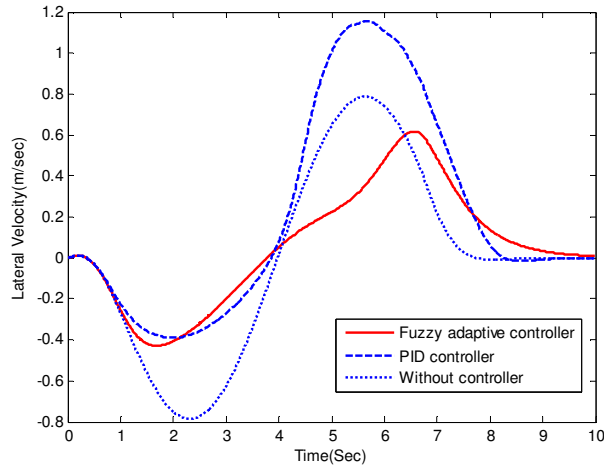

Fig22. Lateral velocity response for LC maneuver

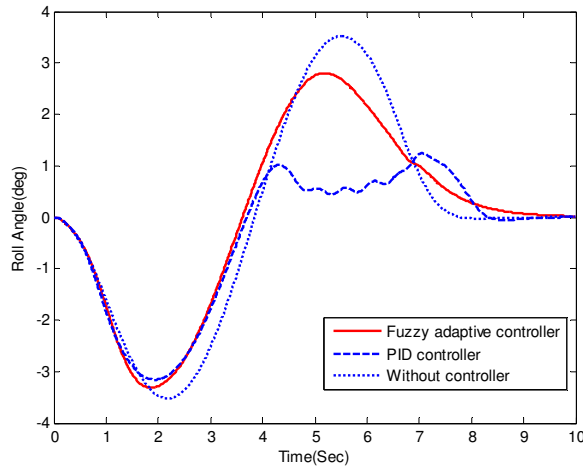

Fig23. Roll angle response for LC maneuver

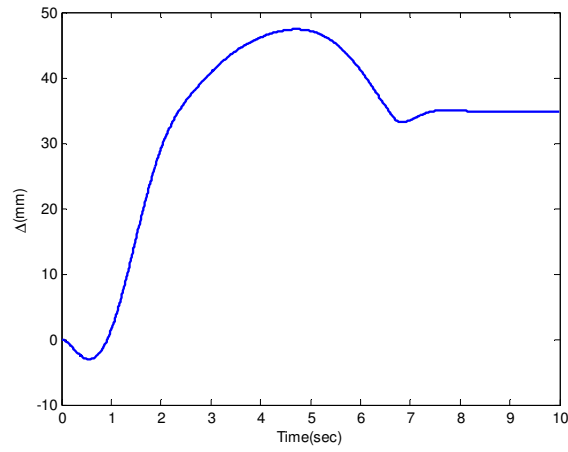

Fig24. Mounting point changing with the adaptive fuzzy controller

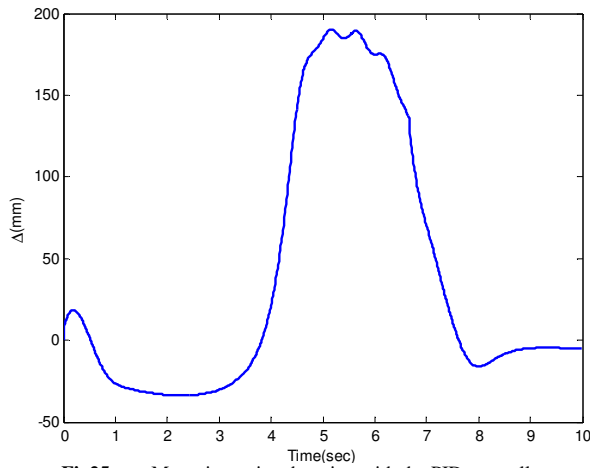

Fig25. Mounting point changing with the PID controller

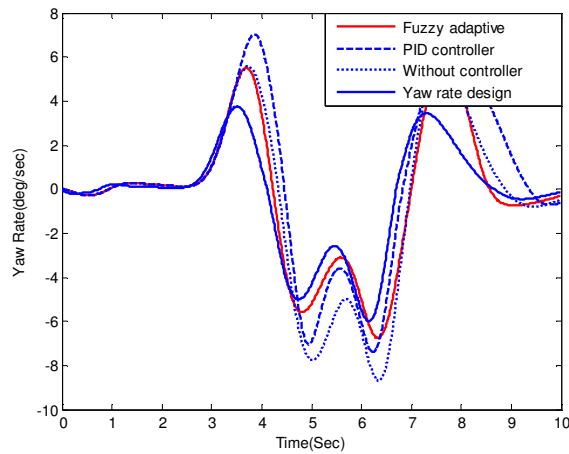

Fig26. Yaw rate response for DLC maneuver

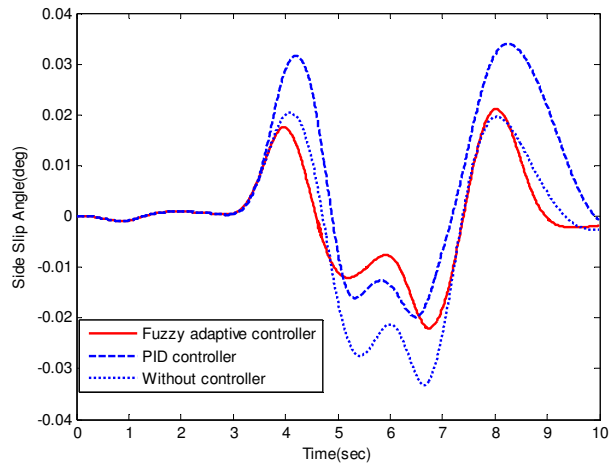

Fig27. Side slip angle response for DLC maneuver

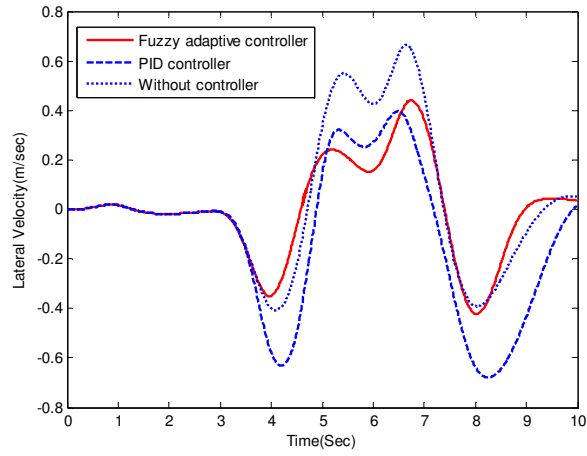

Fig28. Lateral velocity response for DLC maneuver

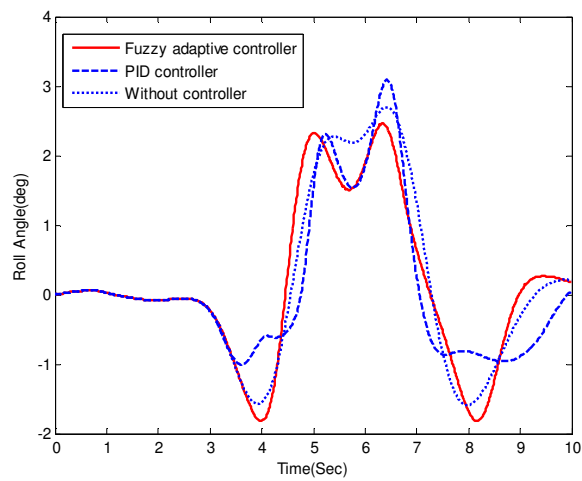

Fig29. Roll angle response for DLC manoeuvre

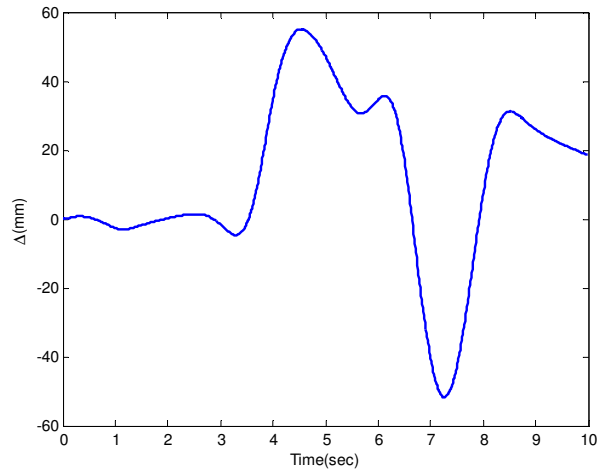

Fig30. Mounting point changing with the adaptive fuzzy controller

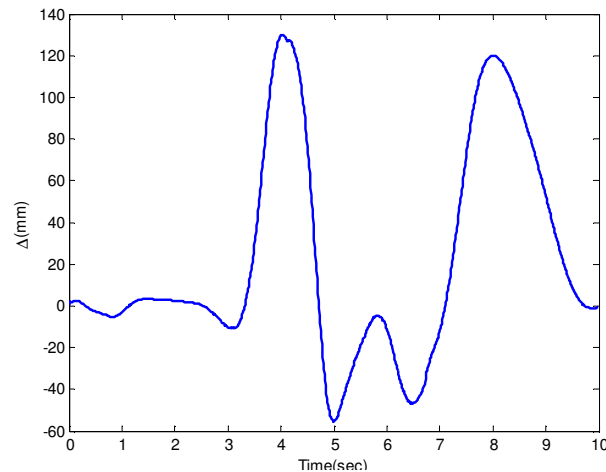

Fig31. Mounting point changing with the PID controller

One of the most difficult tests for realizing the handling and stability is DLC [27]. It has been used for processing of controller performance that adaptive fuzzy controller is better than a PID controller in all conditions and it could be traced target model that it has been illustrated in Fig. 26 up to Fig. 29. PID controller has been enhancing the responses at first and end of the maneuver but midells of maneuvers don't have a good response. Adaptive fuzzy has been doing all of the maneuvers in the maximum domain 50mm and its 120 mm for PID that it has been illustrated in Fig. 30 and Fig. 31

7. Conclusion

AGS is one way to enhancement of vehicle stability especially for high power full and low speed

vehicles that need to stable in difficult road condition. Changing control of suspension mounting point can be done in many directions that changing in perpendicular direction need to use low consumption energy and roll center height can be close to the center of mass gravity. AGS control has been used from 3DOF handling model, PID and adaptive fuzzy controller that results show stability characteristics such as yaw rate, roll angle and side slip angle have been enhanced. While PID controller has not been presented a good response at all times and maneuvers. AGS in vehicle has many uncertainties and AGS model with nonlinear tire must be used adaptive fuzzy typ2.

Nomenclature

α wheel slip angle
 a distance between front axle to the vehicle center of gravity
 a_y vehicle lateral acceleration
 β vehicle side-slip angle
 b distance between rear axle to the vehicle center of gravity
 Δx suspension link mounting point displacement
 ϕ roll angle
 δ steering angle
 $c\alpha$ tire lateral stiffness coefficient
 C_t total vehicle torsional damping coefficient
 F_y lateral force
 \hat{h} height of the center of gravity
 h_R roll center height
 h distance between sprung mass center of gravity and roll axis
 I_x sprung mass moment of inertia about x-axis
 I_z vehicle moment of inertia about z-axis
 K_t total vehicle torsional stiffness
 K_P PI controller proportional gain
 K_{sr} roll steer coefficient
 L vehicle wheel base
 m vehicle mass
 m_s sprung mass
 m_{us} unsprung mass
 r yaw velocity
 T vehicle track
 t time
 u vehicle longitudinal speed
 v vehicle lateral speed

References:

- [1]. R. S. Sharp, "Variable geometry active suspension". Industrial Automation and control: Application in the Automotive industry Digest No.1998/234), IEE Colloquium on, IET, 1998.
- [2]. R. S. Sharp, "Variable geometry active rear suspension for motorcycles". Proc. AVEC, 2000.
- [3]. Y. Watanabe, R. S. Sharp, "Mechanical and Control Design of a variable geometry active suspension system" Vehicle System Dynamics, 32 (2-3), 217-235, 1999.
- [4]. S H. Lee, U K. Lee, C S. Han, "Enhancement of vehicle handling characteristics by suspension kinematic control". Institution of Mechanical Engineers. Vol215, Part D, 2001.
- [5]. U. Lee, "Enhancement of vehicle stability by active geometry control suspension system". International Journal of automotive technology , 293-297,2006.
- [6]. W. J. Evers, A. van der Knaap, et al, "Analysis of a variable geometry active suspension ". Int. Symposium on advanced vehicle control, 2008.
- [7]. Avesta Goodarzi, Ehsan Oloomi & Ebrahim Esmailzadeh, "Design and analysis of an intelligent controller for active geometry suspension systems". Vehicle System Dynamics, 49:1-2, 333-359,2011.
- [8]. Gerard J. Karpik, David J. Karpik, Michael A. Lehman, "Vehicle suspension system with variable geometry", United states patent, P.N: 6,032,752,2000.
- [9]. Jung. Won. Kim, "Control lever structure of active geometry control suspension for vehicles", United states, Patent application publication, Pub. No.: Us 2007/0080509 A1, 2007.
- [10]. Roy. Boston, "Vehicle suspension system with a variable camber system", United states, Patent application publication, Pub. No.: US 2009/0194965 A1, 2009.
- [11]. UN. Koo. Lee, " Active geometry control suspension system and actuating device driving the same", United states, Patent application publication, Pub. No: US 2011/0233880 A1, 2011.
- [12]. Hae Ryong. Choi et al. , "Active geometry control suspension", United states patent, P.N.: US 7,905,500 B2, 2011.
- [13]. L. X. Wang, "Stable adaptive fuzzy control of nonlinear systems," Fuzzy Systems, IEEE Transactions on, vol. 1, pp. 146-155, 1993
- [14]. L. X. Wang, "Stable adaptive fuzzy controllers with application to inverted pendulum tracking," IEEE Trans. Syst., Man, Cybern., vol. 26, no. 5, pp. 677-691, 1996.
- [15]. Y. Tang, "Adaptive robust fuzzy control for output tracking," in Proc. Amer. Control Conf., Jun./Jul. 2004, vol. 2, pp. 1788-1793.
- [16]. Y. Li, Y. Li, and S. Tong, "Adaptive fuzzy decentralized output feedback control for stochastic nonlinear large-scale systems," Neurocomputing, vol. 83, pp. 38-46, 4/15/ 2012.
- [17]. J. Reimpell, H. Stoll, and J.W. Betzler, "The Automotive Chassis: Engineering Principles, 2nd Ed., Society of Automotive Engineers", Inc., Warrendale, PA, 2001.

- [18]. T.D. Gillespie, "Fundamentals of Vehicle Dynamics, Society of Automotive Engineers" , Inc., Warrendale, PA, 1992.
- [19]. P. Melin and O. Castillo, "A new method for adaptive control of nonlinear plants using Type-2 fuzzy logic and neural networks," International Journal of General Systems, vol. 33, pp. 289-304, 2004.
- [20]. L. -X. Wang "A course in Fuzzy systems and control," Prentice Hall, New Jersey, 1996.
- [21]. Z. Haibo, et al., "Adaptive control using interval type-2 fuzzy logic," in IEEE International Conference on Fuzzy Systems, 2009.
- [22]. Balázs Németh, Peter Gáspár, "Enhancement of Vehicle Stability Based on Variable Geometry Suspension and Robust LPV Control", IEEE/ASME, 2011